

DAVEY & CO

LONDON LIMITED ° Est. 1885





Woodlands Business Park
Tenpenny Hill, Thorrington,
Colchester, Essex, CO7 8JD

T: +44(0)1206-500945 F: +44(0)1206-500949

e: info@davey.co.uk www.davey.co.uk

Distributors to the Trade for
Traditional Yacht and Ships Fittings

All measurements and illustrations are given in good faith to, as accurately as possible, portray the product to the reader. Traditional manufacturing methods, however, do produce slight variances in form and size, therefore all information is given as a general guide. Conversion between metric and imperial are as near as possible. Specifications may be altered without notice and we recommend that no apertures are cut nor holes drilled until the item is in the hands of the fitter. Cast products may have minor flaws in the surface, is unavoidable in the traditional sand casting process of gunmetal/bronze fittings.

Terms of business and conditions of sale may be found in our current price list. Marine companies wishing to open a credit account with Davey & Company should apply to us on their headed paper for an application form to accounts@davey.co.uk



History



88 West India Dock Road London E14

In February 1885 Arthur Christopher Davey began a venture that throughout the 20th century evolved into a culture in the manufacture and supply of marine equipment.

From humble beginnings in Leadenhall Street, the company soon moved to its famous address at 88, West India Dock Road, London E 14, where it successfully traded for over 100 years. As one of the UK's oldest marine companies, it is fitting that we are now based in Britain's oldest recorded town of Colchester

Throughout our long history we have endeavoured to give good service with quality, and as yesterdays courtesies become today's traditions, we continue to serve the industry with due care and deference. This philosophy is underpinned by our position as an MOD supplier since our inception.

Within the covers of this catalogue you will find many items that have been in production throughout most of the last century, and are still produced in the same way, from the same patterns, today. Largely made in the midlands of England, we offer genuine cast bronze, brass and galvanised fittings, that do today's job, with a touch of history.

CONTENTS

	SECTION	PAGE
1.	Metals & fastenings guide	3
2.	Custom work	5
3.	Deck hardware & exterior fittings	6
4.	Rigging & sail handling	31
5.	Hot Pot stove	48
6.	Pumps	49
7.	Lighting	49
8.	Signals & Instruments	61
9.	Door, Hatch & Interior Fittings	62
10.	Tools	72
11.	Fastenings	76
12.	Boat care	79
13.	Index	81



At Davey & Company we specialise in the production of traditional fittings using traditional materials. This means that we try to avoid the use of stainless steel and aluminium, which are widely used on modern craft, and favour instead the bronzes, brass, copper and galvanised iron. Apart from being more pleasing to the eye, these materials offer different qualities than their modern counterparts and are perhaps these days less well understood. To help answer some of the more frequently asked questions and to support our product descriptions, the following notes are offered as guidance.

CUSTOM CASTING

See page 5 for information about how our traditional skills can be utilised to produce equipment to your design and specification.

We can also modify some of our standard fittings by, for instance, supplying without fixing holes so that they can be drilled in-situ or perhaps we have an old pattern that would suit you that is not currently in production.

METALS

Gunmetal - LG2 Bronze

The first and most important thing to say here is that gunmetal is bronze, or to be more accurate, it is one of the bronzes and is a nice warm 'browny-gold' colour. Its designation is LG2 (LG stands for leaded gunmetal) and consists of copper (85%), lead (5%), tin (5%) and zinc (5%). Gunmetal is a favoured material to use for traditional boat fittings because it takes casting, machining and polishing very well, is relatively strong and very resistant to salt water, so it does its job for a very long time. All Davey products made from gunmetal include the letters GM in the part number.

Incidentally, 'polishing', in foundry terms, just means that after the item is knocked from the sand mould with its very rough surface, it is sanded down using progressively finer abrasive and polishing belts until it has a mirror smooth and shiny finish. This surface will, on contact with sea air, slowly patinate to a pleasing darker brown colour with tinges of green, but this does not effect its strength, performance or life expectancy and is, in fact, its natural state. If a gleaming polished finish is preferred then any good metal polish can be used to keep it 'as new' and perhaps a smear of petroleum jelly will keep the polished finish longer where the function of the fitting allows.

Aluminium Bronze

For fittings which need a higher strength as well as excellent seawater resistance we use aluminium bronze, designation AB2, which is an alloy consisting of copper (83%), aluminium (10%), nickel (5%) and iron (3%). This is a paler yellow/gold colour and having more than twice the strength of gunmetal is ideal for manufacturing our 'Grabit' boathook and reefing claws. For this material our part numbers include the letters AB.

Brass

There are many alloys in use in the world today called brass, with some being better than others. As we are primarily listing brass items made in England, where the controls are quite stringent, the quality of the brass used is of a high standard. However, it should be noted that brass is best used for interior fittings and should never be used in a submerged position. Brass items contain the letters BR in the number.



Metals & Fastenings Guide

Chrome Plate

Many items in this catalogue are produced and listed with a chrome plated finish (usually on top of brass), and carry the letters CP in the number. Many others that we list only in gunmetal or brass can also be chrome plated to order, and we would be pleased to quote for this service. It should be noted, however, that gravity sand cast items (which is how many of our products are made) can sometimes have small pits on the surface which all but disappear when they are finally polished in the foundry. It is possible when chrome plating these items that these blemishes can sometimes re-appear.

FASTENINGS

Galvanic Corrosion Avoidance

It is very important that the correct fastenings are used to attach each fitting to the boat. It is not enough that the fastenings themselves are of marine quality, they must also be close in the Galvanic Series to the metal the fitting is made from. If they are too dissimilar, the less noble one will corrode.

The following table shows those combinations that are suitable and those that are not. A selection of our traditional marine fastenings can be found towards to end of this catalogue.

Fitting Material	Fastenings	
	Suitable	Not Suitable
Gunmetal	Silicon Bronze or Stainless Steel	Brass
Brass	Brass or Silicon Bronze	Stainless Steel
Galvanised Iron	Galvanised or Stainless Steel	Silicon Bronze

Silicon Bronze

This is an excellent material for the production of marine fastenings. It is high in strength and corrosion resistance and can be formed and machined into most kinds of fastenings including wood screws, machine screws, coach bolts, coach screws and nails. It is more expensive than most other materials, but this is paid back through its high strength and long life.

Fastening Type

For some of our items in this catalogue we have stated a fastening type or size as a guide in relation to normal use and method of fixing. It is recommended, however, that fittings that could take a heavy prolonged or snatch load should be bolted rather than screwed, with reinforcing pads underneath, if required, to spread the load.



Custom Work

The skills and knowledge that enables us to produce our own range of products is now frequently in demand for custom work and refurbishment. From drawings or broken fittings, we can produce patterns and manufacture products exactly as required. These same processes can be used to bring original fittings back to a high standard to enhance restoration projects. Below are just a few of our recent commissions.

From an idea and sketches for a new Hans Christian 41 Traditional yacht.....

...to two beautiful bronze hatches with safety gas springs, toughened glass and drop latch dogs.

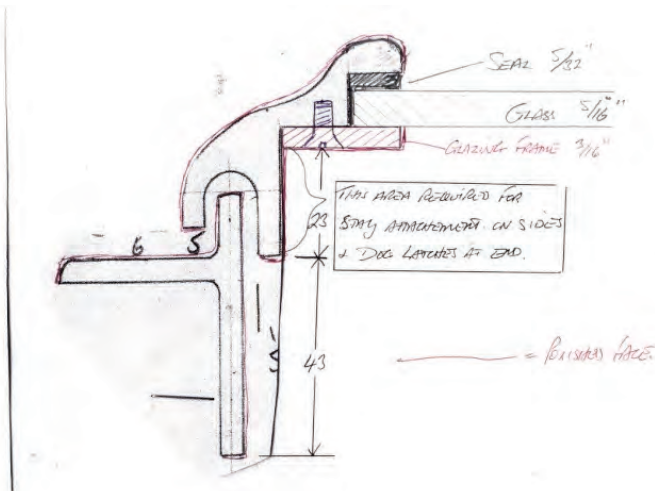

We made patterns from the dimensions of the owner's old steel rudder gear....

...and produced a new set in bronze to fit his stern & rudder



Here are a few from over 50 items we were asked to refurbish as part of a major restoration project.

After stripping, repairing, replicating and re-chroming, this was the result.





Deck Hardware & Exterior Fittings



Polished Bronze Portlights

These heavy duty Davey portlights are traditionally hand made in England to the highest quality and CE approved for upper hull areas and cabin sides. Supplied with outside finishing rings they are fitted with toughened glass and have a polished finish. The 8" round opening and all three oval opening portlights have two closures for additional security. Chrome plate finish and reduced spigot lengths are available to special order. 12" opening and fixed available to special order.

3035



Round Opening

Gunmetal	Glass Diameter	Flange Diameter	Spigot Diameter	Spigot Depth
3035/GM/080	3¼" 84mm	6" 150mm	4⅞" 112mm	1½" 38mm
3035/GM/100	4" 100mm	6½" 170mm	5¼" 134mm	1⅜" 34mm
3035/GM/125	5" 125mm	7¾" 195mm	5¾" 146mm	1¾" 44mm
3035/GM/150	6" 150mm	9⅙" 230mm	6⅞" 175mm	1¾" 44mm
3035/GM/200	8" 200mm	12" 310mm	9½" 243mm	2" 52mm

3036



Round Fixed

Gunmetal	Glass Diameter	Flange Diameter	Spigot Diameter	Spigot Depth
3036/GM/100	4" 100mm	6⅙" 167mm	4⅞" 123mm	1⅜" 35mm
3036/GM/125	5" 125mm	7⅞" 195mm	5¼" 146mm	1¾" 44mm
3036/GM/150	6" 150mm	9⅙" 230mm	6⅞" 175mm	1¾" 44mm
3036/GM/200	8" 200mm	12" 310mm	9½" 243mm	2" 52mm

3033



Oval Opening

Gunmetal	Glass Size	Flange Size	Spigot Size	Spigot Depth
3033/GM/168	6⅞" x 3¾" 165 x 93mm	9¼" x 7" 250 x 180mm	8" x 5¼" 203 x 132mm	1¼" 32mm
3033/GM/218	8½" x 4⅞" 218 x 125mm	11¼" x 8⅞" 300 x 206mm	9¼" x 6⅞" 248 x 155mm	1⅞" 28mm
3033/GM/275	11" x 6¼" 280 x 160mm	14¼" x 9¼" 362 x 248mm	12⅞" x 7⅞" 308 x 187mm	1¼" 32mm

3039



Oval Fixed

Gunmetal	Glass Size	Flange Size	Spigot Size	Spigot Depth
3039/GM/168	6⅞" x 4" 175 x 100mm	8⅞" x 6" 225 x 150mm	7½" x 4⅞" 192 x 117mm	1¼" 32mm
3039/GM/218	8½" x 4⅞" 215 x 125mm	10½" x 6⅞" 270 x 175mm	9⅞" x 5⅞" ³ 238 x 143mm	1¼" 32mm
3039/GM/275	10¾" x 6" 272 x 150mm	14⅞" x 9¼" 358 x 237mm	12" x 7⅞" 304 x 182mm	1¼" 45mm

Windscreen Fittings

The set consists of one centre and one pair of side brackets cast in gunmetal and chrome plated. Supplied without glass.



	Centre Bracket Height	Side Bracket Height
8750/CP/222	9⅞" 238mm	3½" 89mm
8750/CP/287	12" 300mm	3½" 89mm





Drip Cup



Cast in bronze with a polished finish, this new addition to our range is designed to catch the condensation that can drip from portholes. Also available chrome plated.

Bronze	Chrome	Width	Height	Projection
3010/GM	3010/CP	4¾" 120mm	2" 52mm	1¼" 34mm

Fly Screens



These fly screens are manufactured from stainless steel mesh and have a flexible outer rim that holds them firmly in the bore of the porthole. As a simple push fit they are easily installed without tools and can be simply removed and stored when not required. The door remains fully usable when the fly screens are in place. There is a size to suit each Davey porthole or any other porthole with the same internal shape and size. Other sizes can be made to special order.

Round



Part Number	Outside Diameter / Porthole Bore.	To suit Davey Porthole
3020/SS/080	4⅞" 105mm	3035/GM/080 3¼" 80mm
3020/SS/100	5" 125mm	3035/GM/100 4" 100mm
3020/SS/125	5⅝" 143mm	3035/GM/125 5" 125mm
3020/SS/150	6⅝" 168mm	3035/GM/150 6" 150mm
3020/SS/200	9⅞" 234mm	3035/GM/200 8" 200mm

Oval



Part Number	Approx. size	To suit Davey Porthole
3030/SS/168	7¼" x 5" 195 x 125mm	3033/GM/168
3030/SS/218	9⅝" x 5⅝" 245 x 150mm	3033/GM/218
3030/SS/275	11⅞" x 7¼" 300 x 180mm	3033/GM/275

Portlight Rings

Cast in gunmetal with a polished finish, these flat rings are supplied as outside finishing rings with our portholes but can also be ordered separately here for use as glazing rings or other applications. Also available chrome plated or in polished stainless steel.



Round	Outside Diameter		Inside Diameter	
3036/GM/100/OSR	6⅞"	167mm	4⅞"	123mm
3035/GM/100/OSR	6⅝"	169mm	5¼"	134mm
3035/GM/125/OSR	7¼"	197mm	5⅝"	149mm
3035/GM/150/OSR	9¼"	235mm	6⅝"	175mm
3035/GM/200/OSR	12"	304mm	9⅝"	243mm



Oval	Width		Height	
	Inside	Outside	Inside	Outside
3033/GM/168/OSR	8" 203mm	9¾" 250mm	5¼" 132mm	7" 180mm
3033/GM/218/OSR	9¾" 249mm	11¾" 300mm	6⅞" 155mm	8⅞" 206mm
3033/GM/275/OSR	12⅞" 307mm	14¼" 362mm	7⅞" 186mm	9¼" 248mm
3039/GM/168/OSR	7½" 192mm	9" 230mm	4⅝" 116mm	6⅞" 157mm
3039/GM/218/OSR	9⅞" 234mm	11" 278mm	5½" 140mm	7¼" 182mm
3039/GM/275/OSR	12" 305mm	14⅞" 358mm	7⅞" 182mm	9¼" 237mm



Deck Hardware & Exterior Fittings

Deck Lights

From the early 1900s, Davey & Company has been producing a range of deck prisms to bring natural light down below. Manufactured in England these prisms are solid glass with either flat bronze frames, where the glass is rabbetted in, or deep bronze frames for thinner decks. In both cases a marine quality black mastic should be used such as a polysulphide/polyurethane/MS Polymer to improve adhesion the glass should be abraded first where the sealant touches. Frames can be chrome plated to order or, in some cases, supplied in polished stainless steel. (AIS 316).

Rabbed Deck Prisms

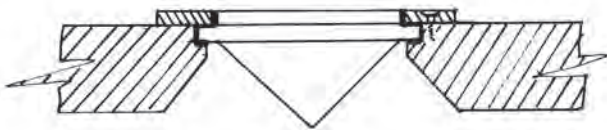

In this style the glass is set first into the deck using a marine quality mastic and then a flat frame is positioned over the rim of the glass and screwed down. This is only suitable where there is sufficient depth of wood to support the weight of anyone walking on it.

2411 Rabbed



Bronze c/w Glass	Stainless Steel c/w Glass	Overall Size	Depth	Nominal Glass Size	Spare Glass
2411/GM/225	2411/SS/225	10 ¹ / ₄ " x 4 ⁷ / ₈ " 260 x 124mm	2 ¹ / ₄ " 57mm	9" x 3" 229 x 75mm	2409/OO/225/075
2411/GM/250	2411/SS/250	11 ³ / ₈ " x 5 ³ / ₈ " 290 x 137mm	2 ¹ / ₄ " 57mm	10" x 3 ¹ / ₂ " 260 x 89mm	2409/OO/250/087
2411/GM/312	2411/SS/312	14 ¹ / ₂ " x 6 ¹ / ₂ " 368 x 165mm	2 ¹ / ₂ " 64mm	12 ¹ / ₂ " x 4 ¹ / ₂ " 318 x 114mm	2409/OO/312/112

2412 Round Prism



Bronze c/w Glass	Stainless Steel c/w Glass	Overall Diameter	Depth	Glass Diameter	Spare Glass
2412/GM/162	2412/SS/162	6 ¹ / ₈ " 156mm	3/4" 19mm	4 ³ / ₈ " 112mm	2420/OO/110
2412/GM/194	2412/SS/194	7 ³ / ₄ " 195mm	3/4" 19mm	5 ¹ / ₂ " 140mm	2420/OO/137
2412/GM/250	2412/SS/250	10" 250mm	3/4" 19mm	8" 200mm	2420/OO/200

2413 Melon



The melon has the greatest light output, but also the greatest depth, so care should be taken when fitting above walkways or other areas to ensure adequate headroom.

Bronze c/w Glass	Stainless Steel c/w Glass	Overall Diameter	Depth	Glass Diameter	Spare Glass
2413/GM	2413/SS	7 ³ / ₄ " 195mm	5 ¹ / ₂ " 140mm	5 ¹ / ₂ " 140mm	2408



Deep Frame Deck Prisms

The style of this prism is ideal for thinner decks such as steel, aluminium or fibreglass. The frame is fixed to the deck first and the glass is then set into the frame from the top using a good quality marine mastic.

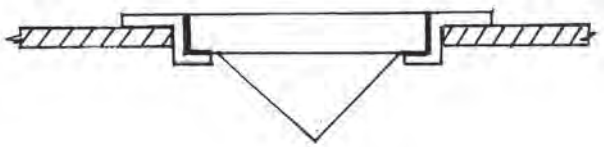

2414 Deep Frame Oblong



Gunmetal c/w Glass	Overall Size	Depth	Nominal Glass Size	Spare Glass
2414/GM/225	11" x 5" 279 x 127mm	2" 50mm	9" x 3" 229 x 75mm	2410/OO/225/075
2414/GM/250	12¼" x 5¾" 311 x 146mm	2¼" 57mm	10" x 3½" 254 x 89mm	2410/OO/250/087
2414/GM/300	14½" x 6½" 368 x 165mm	2½" 64mm	12" x 4" 305 x 100mm	2410/OO/300/100

2415 Deep Frame Melon



Bronze c/w Glass	Stainless Steel c/w Glass	Overall Diameter	Depth	Glass Diameter	Spare Glass
2415/GM	2415/SS	8⅝" 206mm	4½" 115mm	5½" 140mm	2407

This is a fairly recent development which allows the very popular melon prism to be more easily fitted into thinner decks. Now available with stainless steel frame.

2418 Deep Frame Round Prism



Gunmetal c/w Glass	Overall Diameter	Depth	Glass Diameter	Spare Glass
2418/GM	10" 250mm	1⅙" 27mm	8" 200mm	2421/OO/200

This prism is an effective alternative for the bulls eye pattern below.

2417 Bulls Eye-Deep Frame



Gunmetal c/w Glass	Overall Diameter	Depth	Glass Diameter	Spare Glass
2417/GM/206	8⅝" 206mm	1¾" 45mm	6" 150mm	2416/OO/150
2417/GM/260	10¼" 260mm	2" 50mm	8" 200mm	2416/OO/200



Deck Hardware & Exterior Fittings

Cowl Vents - Cast Bronze

Heavy cast bronze cowl vents with flush bronze deck plates, produced in the UK by traditional methods. The outer surface is polished and the inside a contrasting sateen finish, which is attractive in itself but also aids internal painting if required. A securing screw is fitted to allow the vent to be locked in any position and a blanking cap and key are included for when the vent is removed. Available in two sizes. They can be chrome plated to order or supplied with a matt finish.



Gunmetal	Chrome	Thread Diameter	Flange Diameter	Height	Cowl Diameter
2470/GM/075	2470/CP/075	3" 75mm	4½" 120mm	7" 178mm	5½" 140mm
2470/GM/100	2470/CP/100	4" 100mm	6½" 165mm	10½" 266mm	8" 200mm



Cast Cowl Ventilator

Polished brass or chrome plate with optional blanking caps.

Brass	Chrome	Internal Diameter	Flange Diameter	Height	Cowl Diameter
5400/BR	5400/CP	2½" 63mm	4½" 115mm	8½" 220mm	5½" 130mm
Blanking Caps		Brass 5401/BR		Chrome 5401/CP	

3" Style

4" & 5" Style



Mushroom Ventilators

Gunmetal	Inside Diameter	Flange Diameter	Closed Height	Fastenings
2454/GM/075	2¼" 70mm	4½" 105mm	1½" 35mm	No. 8
2454/GM/100	3¼" 95mm	5½" 140mm	1½" 35mm	No. 8
2454/GM/125	4¼" 120mm	6½" 175mm	1¾" 45mm	No. 8

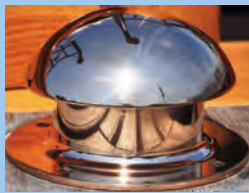

Gunmetal	Inside Diameter	Flange Diameter	Closed Height	Fastenings
2453/GM/075	3" 75mm	5½" 140mm	3¼" 82mm	No. 10
2453/GM/100	4" 100mm	6¼" 170mm	3¾" 95mm	No. 12
2453/GM/125	5" 125mm	7¼" 197mm	4" 100mm	No. 12
2453/GM/150	6" 150mm	8½" 216mm	5¼" 133mm	No. 12

Glazed Gunmetal Ventilator

A versatile vent with two glazed segments in the top admitting both light and air to the cabin. Fitted with 'T' handle.

Gunmetal	Inside Diameter	Flange Diameter	Closed Height	Fastenings
2452/GM	4½" 114mm	7" 178mm	2¾" 60mm	No. 10



Shell Ventilator

This attractive vent is especially popular for ventilating the engine area.

Gunmetal	Width	Length	Height	Fastenings
2467/GM/01	4¼" 122mm	6" 150mm	2¾" 65mm	No. 8
2467/GM/02	6¾" 163mm	7½" 190mm	2¼" 70mm	No. 8



Deck Hardware & Exterior Fittings



Half Cowl Vent

These vents are designed to be fitted to cabin sides for intakes and exhaust for ventilations. Made from bronze and handed. 6" X 4" (H x W)

2475/GM/LH	Starboard Side Aft Facing Inlet
2475/GM/RH	Starboard Side Fwd. Facing Inlet

Cast Bronze Hatch

Heavy duty bronze hatch fitted with two gas springs for ease of use and safety. The lid is secured from the inside with two ring nuts locating onto drop latches. Fitted with 8mm toughened glass. Manufactured to order.

Frame size: 18.3/4" 476mm square
 Spigot size: 16" 406mm square
 Weight: 50 lbs 22.5 kgs



Part No. 3260/GM

Deck Screws - Cast Bronze

Heavy duty cast gunmetal without spigot, polished finish. Available chrome plated to order. Supplied with key.



Gunmetal	BSP Thread	Diameter	Fastening
2430/GM/075	3" 75mm	4 3/4" 120mm	No. 8
2430/GM/100	4" 100mm	6 1/2" 165mm	No. 10



Heavy duty cast gunmetal with BSP threaded spigot, polished finish. Available chrome plated to order. Supplied with key.

Gunmetal	BSP Thread	Diameter	Fastening
2433/GM/037	1 1/2"	3 3/8" 93mm	No. 8

Larger sizes available to special order



Polished brass or chrome with integral handle in cap

Brass	Chrome	Legend	Hose Size	Fastenings
0710/BR/38	0710/CP/38	Water	1 1/2" 38mm	No. 8
0711/BR/50	0711/CP/50	Diesel	2" 50mm	No. 8
0712/BR/38	0712/CP/38	Waste	1 1/2" 38mm	No. 8

Brass Nameplates



9523/BR/DIESEL/75	Diesel Nameplate
9523/BR/WATER/75	Water Nameplate



Fuel Tank Vent

Brass finish or chrome plated.

Brass	Chrome
2435/BR	2435/CP
For 5/8" / 16mm hose	

Drain Plug Captive

Stamped drain bungs with a captive retainer and rubber seal. BR/SD277-SC
 BR/SD277-CP



Drain Plug

Cast in gunmetal unpolished. Fitted with neoprene washer.



Gunmetal	Bore	Cut-out Dia	Flange Diameter	Hull Thickness
1441/GM/12	1/2" 12mm	3/4" 19mm	1 5/8" 42mm	5/16" 8mm
1441/GM/19	3/4" 19mm	1" 25mm	2" 50mm	3/8" 10mm
1441/GM/25	1" 25mm	1 1/16" 30mm	2 1/8" 54mm	3/8" 10mm
1441/GM/32	1 1/4" 32mm	1 1/2" 38mm	2 1/2" 65mm	3/8" 10mm





Deck Hardware & Exterior Fittings

Cleats

Davey & Co. produce a wide range of bronze cleats. The items on these pages are those currently in production, but other patterns and sizes are available to special order. Please enquire if the item you need is not shown here. Most gunmetal items can be chrome plated on request.

1084 Pillar Cleat



1084/GM/470 has M16 a tapped base

Gunmetal	Length	Base Width	Fastenings
1084/GM/062	2½" 62mm	½" 12mm	No. 6 screw
1084/GM/100	4" 100mm	⅞" 22mm	⅜" 5mm
1084/GM/125	5" 125mm	1" 25mm	¼" 6mm
1084/GM/150	6" 150mm	1⅛" 28mm	¼" 6mm
1084/GM/175	7" 175mm	1¼" 32mm	¼" 6mm
1084/GM/200	8" 200mm	1⅝" 36mm	⅜" 8mm
1084/GM/250	10" 250mm	1⅞" 40mm	⅜" 8mm
1084/GM/280	11" 280mm	1¾" 40mm	3/8" 10mm
1084/gm/470	18½" 470mm	2½" 60mm	M16 Tapped

1073 Jamb Cleat



Gunmetal	Length	Base Width	Fastenings
1077/GM/100	4" 100mm	1½" 32mm	No. 8 screw
1077/GM/125	5" 125mm	1⅝" 38mm	No. 8 screw
1077/GM/150	5⅝" 150mm	1⅞" 40mm	No. 10 screw

1077 Flat Top Cleat



Gunmetal	Length	Base Width	Fastenings
1073/GM/075	3" 75mm	⅝" 16mm	No. 6 screw
1073/GM/100	4⅞" 105mm	¾" 19mm	No. 8 screw
1073/GM/125	5" 125mm	1" 25mm	No. 10 screw
1073/GM/150	6" 150mm	1" 25mm	No. 12 screw
1073/GM/175	7" 175mm	1" 25mm	No. 14 screw

1078 Open Top Cleat



Gunmetal	Length	Base Width	Fastenings
1078/GM/100	4" 100mm	⅞" 22mm	⅜" 5mm
1078/GM/125	5" 125mm	1" 25mm	¼" 6mm
1078/GM/150	6" 150mm	1⅛" 28mm	¼" 6mm
1078/GM/175	7" 175mm	1¼" 32mm	⅜" 8mm

1089/BR/048 & 1089/BR/070



Left Hand

Right Hand

1089 Tubular Jamb Cleat

Part No	Length	Base Width	Max Line Size	Fastenings
1089/BR/048	¾" 82mm	¾" 19mm	6mm	No. 6 screw
1089/BR/070	¾" 82mm	¾" 19mm	8mm	No. 8 screw
1089/GM/LH/081	¾" 82mm	7/8" 22mm	10mm	No. 8 screw
1089/GM/LH/087	¾" 89mm	7/8" 22mm	12mm	No. 8 screw
1089/GM/RH/081	¾" 82mm	7/8" 22mm	10mm	No. 8 screw
1089/GM/RH/087	¾" 89mm	7/8" 22mm	12mm	No. 8 screw

1070 Horn Cleat



Part No	Material	Length	Base Width	Fastenings
BR/SD620-POL	Naval Brass	2 7/8" 70mm	¾" 19mm	No 6 Screws (x2)
BR/SD621-POL	Nava Brass	4" 100mm	7/8" 22mm	No 8 Screws (x2)
1075/GM/100	Gunmetal	4" 100mm	1⅝" 35mm	No 8 Screws (x2)
1075/GM/125	Gunmetal	5" 125mm	1⅞" 42mm	No10 Screws (x2)
1075/GM/150	Gunmetal	5¾" 148mm	2" 50mm	No10 Screws (x4)

1075 Tall Horn Cleat



The 1075 pattern is much heavier duty than the 1070 pattern.

Deck Hardware & Exterior Fittings



1085 Herreshoff Cleat



Herreshoff style cleat with hollow top bar. The bases are tapped to accommodate M16 studding or bolts

Part No.	Material	Length	Base Width	Fastenings
1085/GM/300	Gunmetal	11¼" 296mm	2⅜" 32mm	M16
1085/CP/300	Chrome	11¼" 296mm	2⅜" 32mm	M16

Torpedo Cleats



1098

1096

Gunmetal	Head Length	Base Length	Base Width	Fastenings
1096/GM/056	2 ¼" 56mm	2⅞" 75mm	1" 25mm	No. 6 screw
1096/GM/068	2¾" 68mm	3⅝" 92mm	1⅝" 34mm	No. 6 screw
1098/GM/087	3½" 89mm	2⅞" 73mm	1¼" 32mm	No. 6 screw
1098/GM/112	4½" 114mm	4⅜" 112mm	1½" 38mm	No. 8 screw
1098/CP/087	3½" 89mm	2⅞" 73mm	1¼" 32mm	No. 6 screw
1098/CP/112	4½" 114mm	4⅜" 112mm	1½" 38mm	No. 8 screw

1088 Bar Cleat – Bolt Through



Gunmetal	O.A. Height Above Base Plate	Base Dimensions	Bolt Size
1088/GM/162	2½" 64mm	6½" x 2¼" 165mm x 57mm	4" x ⅞" 100mm x 11mm
1088/GM/238	3¼" 82mm	9½" x 2½" 241mm x 64mm	6" x ⅝" 150mm x 16mm

Please note that the oval teak bar is not supplied with this item.

1099 Bar Cleat – Screw Down



Gunmetal	O.A. Height	Base Dimensions	Fasteners
1099/GM	2½" 64mm	2⅞" x 1½" 73mm x 38mm	⅜" 5mm

Brackets are sold singularly, therefore two need to be ordered to make one cleat.

Gunmetal Jamming Cleat

Designed for sheets and halyards for quick use. Made in Gunmetal. Fixings with either M8 or 5/16 Countersunk bolts.



1092

Gunmetal	Type	Length
1092/GM/150	Double Cleat	6" 150mm

Tufnol Cleats

Strong, lightweight and resistant to the marine environment, these genuine Tufnol cleats will give excellent service for many years.



1093

	Type	Length
1093/00/280	Double Cleat	11" 280mm

Wooden Cleats

In teak or varnished ash, these cleats add warmth and style to any vessel. Larger sizes up to 20" are also available to special order.



Ash	Teak	LengthBase	Width
1097/AH/100	1097/TK/1004"	100mm	⅝" 16mm
1097/AH/125	1097/TK/1255"	125mm	¾" 19mm
1097/AH/150	1097/TK/1506"	150mm	¾" 19mm
1097/AH/175	1097/TK/1757"	175mm	⅞" 22mm
1097/AH/200	1097/TK/2008"	200mm	1⅙" 24mm
1097/AH/225	1097/TK/2259"	225mm	1⅙" 30mm
1097/AH/250	1097/TK/25010"	150mm	1¼" 32mm
1097/AH/300	1097/TK/30012"	300mm	1½" 38mm



Deck Hardware & Exterior Fittings

Bollard Cleats

All bollard cleats are produced in polished bronze and can be chrome plated to order. Many can also be produced in galvanised iron in batch quantities.

1079 Rounded End Bollard



Gunmetal	Length		Base Dia.		Fastenings	
1079/GM/125	5"	125mm	2½"	65mm	¼"	6mm
1079/GM/150	6"	150mm	3½"	90mm	¼"	6mm
1079/GM/187	7½"	187mm	4¾"	120mm	⅝"	8mm
1079/GM/225	9"	225mm	5"	125mm	⅝"	8mm

1080 Threaded Bolt Bollard



Gunmetal	Length		Base Dia.		Bolt Size
1080/GM/100	4"	100mm	2¼"	57mm	3½" x ⅜" 89mm x 11mm
1080/GM/125	5"	125mm	2⅝"	67mm	4" x ½" 100mm x 12mm
1080/GM/150	6"	150mm	2¾"	70mm	4¼" x ½" 108mm x 12mm

1081 Flat Ended Bollard



Gunmetal	Length		Base Dia.		Fastenings
1081/GM/062	2½"	62mm	2"	50mm	No. 8 screw
1081/GM/100	4"	100mm	2¾"	70mm	No.10 screw
1081/GM/125	5"	125mm	3"	75mm	¼" 6mm
1081/GM/150	6"	150mm	3¼"	83mm	¼" 6mm

1082 Flat Ended Bollard Bolted



Part Number		Length	Base Dia.	Bolt Size
1082/GM/150	Gunmetal	6" 150mm	3⅝" 85mm	4½" x ½" 115mm x 12mm
1082/CP/150	Chrome			

Designed as a lifting cleat. This is made in gunmetal, with 2 off M6 fastenings. This is sold as a cleat and is not tested for lifting.



1074 Lifting Cleat

Part Number	Length	Height overall	Height of Arms	Base Width
1074/GM/125	5" 125mm	TBC	TBC	TBC

1149 Belay Cleat



Gunmetal	Arm Length	Base Dimensions	Height	Fastenings
1149/GM	7½"	4½" x 5" 90mm x 115mm	3⅝" 80mm	⅝" C/S 14mm

1150



Mooring Bitt

Gunmetal	Arm Length	Base Dimensions	Height	Fastenings
1150/GM	6½"	5" x 5" 125mm x 125mm	4⅝" 105mm	⅝" 8mm



Bollards

All bollards are produced in polished bronze and can be chrome plated to order. Many can also be produced in galvanised iron in batch quantities.

1127 Raked 12"



Gunmetal	Length	Base Dimensions	Fastenings
1127/GM/300	12" 300mm	11 ³ / ₈ " x 3 ¹ / ₂ " 290mm x 89mm	³ / ₈ " 10mm
1127/GM/450 (Slight Raking)	18" 457mm	18" x 5 ¹ / ₂ " 457mm x 140mm	¹ / ₂ " 12mm

1129 Low Profile Raked



A range of stylish raked bollards with a lower profile, ideal for modern classics and lighter displacement boats of all types. Can be chrome plated to order.

Gunmetal	Height	Base Dimensions	Fastenings
1129/GM/175	1 ⁷ / ₈ " 48mm	6 ³ / ₄ " x 1 ⁷ / ₈ " 175mm x 47mm	¹ / ₄ " 6mm
1129/GM/225	2 ¹ / ₂ " 64mm	9" x 2 ¹ / ₂ " 225mm x 64mm	⁵ / ₁₆ " 8mm
1129/GM/300	3" 75mm	12" x 3" 300mm x 75mm	⁵ / ₁₆ " 8mm

1126 Mooring Bits



Gunmetal	Length	Base Width	Fastenings
1126/GM/100	4" 100mm	1 ¹ / ₁₆ " 28mm	³ / ₁₆ " 5mm
1126/GM/150	6" 150mm	1 ¹ / ₂ " 38mm	¹ / ₄ " 6mm
1126/GM/200	8" 200mm	1 ⁷ / ₈ " 48mm	⁵ / ₁₆ " 8mm
1126/GM/250	10" 250mm	2 ¹ / ₄ " 57mm	⁵ / ₁₆ " 8mm

1137 Cross Bollard



Gunmetal	Arm Length	Base Dimensions	Height	Fastenings
1137/GM/118	4 ⁵ / ₈ " 117mm	5" x 3 ³ / ₄ " 125mm x 95mm	5" 125mm	¹ / ₄ " 6mm
1137/GM/150	6 ¹ / ₄ " 159mm	5 ⁵ / ₈ " x 4 ⁵ / ₈ " 149mm x 117mm	7" 178mm	⁵ / ₁₆ " 8mm
1137/GM/187	7 ¹ / ₂ " 190mm	7" x 5 ¹ / ₂ " 178mm x 140mm	8 ¹ / ₄ " 210mm	³ / ₈ " 10mm

1086 Thames Cleat



Gunmetal	Horn Length	Base Dimensions	Fastenings
1086/GM/150	6" 150mm	5" x 1 ¹ / ₄ " 125mm x 45mm	³ / ₁₆ " 5mm
1086/GM/200	8" 200mm	7" x 2 ¹ / ₄ " 175mm x 56mm	⁵ / ₁₆ " 8mm
1086/GM/250	10" 250mm	8 ³ / ₄ " x 3" 222mm x 75mm	³ / ₈ " 10mm

1138 Cross Head Bollard



Gunmetal	Length	Height	Base L x W	Fastenings
1138/GM/220	8 ¹ / ₂ " 220mm	4 ³ / ₈ " 110mm	7" x 2 ³ / ₄ " 180 x 70mm	¹ / ₄ " 6mm



Deck Hardware & Exterior Fittings

Deck Fairleads

Davey & Company produce a wide range of fairleads cast in bronze with a polished finish. In addition to those shown here, we have other patterns available for casting to special order. These fairleads can be chrome plated on request. Some fairleads can be produced in galvanised iron in batch quantities.

1111 Straight Fairlead



1112 Handed Fairlead



Straight Pattern

Gunmetal	Length		Width		Aperture		Fastenings
1111/GM/100	4"	100mm	7/8"	22mm	1 1/8" x 5/8"	35 x 16m	No. 8
1111/GM/125	5"	125mm	1"	25mm	1 7/8" x 3/4"	48 x 20m	No. 10
1111/GM/150	6"	150mm	1 1/16"	30mm	2 1/4" x 1 5/16"	57 x 24m	No. 12
1111/GM/175	7"	175mm	1 3/8"	34mm	2 1/2" x 1"	64 x 25m	No. 14
1111/GM/200	8"	200mm	1 1/2"	38mm	2 7/8" x 1 1/8"	74 x 30m	6mm
1111/GM/225	9"	228mm	1 1/2"	38mm	3 1/4" x 1 1/4"	82 x 31m	8mm
1111/GM/250	10"	255mm	1 3/4"	45mm	3 3/4" x 1 1/2"	97 x 35mm	8mm
1111/GM/300	12"	300mm	2 1/16"	55mm	4 1/2" x 2"	115 x 50mm	8mm

Handed Pattern



Left Hand



Right Hand

Left Hand	Right Hand	Length		Width		Aperture		Fastenings
1112/GM/LH/100	1112/GM/RH/100	4"	100mm	3/4"	19mm	1 1/8" x 5/8"	28 x 16mm	No. 8
1112/GM/LH/125	1112/GM/RH/125	5"	127mm	1"	25mm	1 1/2" x 3/4"	38 x 20mm	No. 10
1112/GM/LH/150	1112/GM/RH/150	6"	150mm	1 1/4"	32mm	1 3/4" x 7/8"	44 x 22mm	No. 12
1112/GM/LH/200	1112/GM/RH/200	8"	203mm	1 1/2"	37mm	2 1/2" x 1 1/4"	64 x 32mm	6mm
1112/GM/LH/225	1112/GM/RH/225	9"	228mm	1 1/2"	38mm	2 7/8" x 1 3/8"	73 x 34mm	8mm
1112/GM/LH/250	1112/GM/RH/250	10"	255mm	1 7/8"	48mm	3 1/4" x 1 1/2"	83 x 38mm	8mm
1112/GM/LH/300	1112/GM/RH/300	11 3/4"	300mm	2 1/8"	55mm	3 3/4" x 1 7/8"	95 x 48mm	8mm
1112/GM/LH/370	1112/GM/RH/370	14 1/2"	370mm	2"	51mm	5" x 2 1/2"	125 x	

m 10mm 12mm

1102 Closed Fairlead



Gunmetal	Length	Base Width	Aperture	Fastenings
1102/GM/100	4" 100mm	1 1/2" 32mm	1 3/8" x 5/8" 35mm x 15mm	No. 8
1102/GM/150	6" 150mm	1 3/8" 38mm	2" x 7/8" 50mm x 22mm	No. 10
1102/GM/200	8" 200mm	1 5/8" 40mm	3 1/2" x 1 1/8" 90mm x 28mm	No. 14

1107 Fairlead with Roller



Gunmetal	Length	Base Width	Aperture	Fastenings
1107/GM/300	12 1/4" 310mm	2 3/4" 70mm	1 3/8" x 5/8" 115mm x 55mm	16mm
1107/GM/400	16" 405mm	3 1/4" 83mm	2" x 7/8" 160mm x 70mm	18mm

Deck Hardware & Exterior Fittings



1109 Straight Lipped Fairlead



Gunmetal	Length	Width	Aperture	Fastenings
1109/GM/100	4" 100mm ⁷	$\frac{7}{8}$ " 22mm	$1\frac{3}{8}$ " x $\frac{1}{2}$ " 35 x 13mm	No. 8
1109/GM/150	6" 150mm	1" 25mm	2" x $\frac{7}{8}$ " 50 x 22mm	No. 8
1109/GM/200	8" 203mm	$1\frac{1}{2}$ " 38mm	3" x $1\frac{1}{8}$ " 75 x 30mm	No. 12

1113 Handed Lipped Fairlead



Left Hand

Gunmetal					
Left Hand	Right Hand	Length	Width	Aperture	Fastenings
1113/GM/LH/100	1113/GM/RH/100	4" 100mm	$\frac{7}{8}$ " 22mm	$1\frac{1}{4}$ " x $\frac{3}{8}$ " 32 x 16mm	No. 8
1113/GM/LH/150	1113/GM/RH/150	6" 150mm	1" 25mm	2" x $\frac{7}{8}$ " 50 x 22mm	No. 8
1113/GM/LH/200	1113/GM/RH/200	8" 203mm	$1\frac{1}{4}$ " 32mm	$2\frac{1}{2}$ " x $1\frac{1}{8}$ " 65 x 28mm	No. 14

1115 Lock Over Handed Lipped Fairlead



Left Hand

Gunmetal					
Left Hand	Right Hand	Length	Width	Aperture	Fastenings
1115/GM/LH/100	1115/GM/RH/100	4" 100mm	$\frac{7}{8}$ " 22mm	$1\frac{3}{4}$ " x $\frac{5}{8}$ " 45 x 16mm	No. 8
1115/GM/LH/150	1115/GM/RH/150	6" 150mm	$1\frac{1}{4}$ " 32mm	2" x $\frac{7}{8}$ " 50 x 22mm	No. 10
1115/GM/LH/165	1115/GM/RH/165	7" 180mm	$1\frac{1}{4}$ " 32mm	$2\frac{1}{4}$ " x 1" 57 x 25mm	No. 12
1115/GM/LH/200	1115/GM/RH/200	8" 205mm	$1\frac{1}{2}$ " 38mm	$2\frac{3}{4}$ " x $1\frac{1}{8}$ " 70 x 28mm	No. 14

1120 & 1121 Straight Sunken Fairlead



Gunmetal	Length	Width	Aperture	Fastenings
1120/GM/200	8" 203mm	1" 25mm	$3\frac{3}{4}$ " x $1\frac{1}{4}$ "	No. 12
1121/GM/200	8" 203mm	$1\frac{1}{2}$ " 38mm	95 x 32mm	No. 14

Available in two width options.

1122 Handed Sunken Fairlead



Gunmetal	Length	Width	Aperture	Fastenings
1122/GM/200/LH	8" 203mm	$1\frac{1}{2}$ " 38mm	$3\frac{3}{4}$ " x $1\frac{1}{4}$ "	No. 12
1121/GM/200/RH	8" 203mm	$1\frac{1}{2}$ " 38mm	95 x 32mm	No. 12

1124 Semi Sunk Fairlead



Gunmetal	Length	Width	Aperture	Fastenings
1124/GM/180	$7\frac{1}{4}$ " 184mm	$1\frac{1}{4}$ " 31mm	$2\frac{1}{6}$ " x $1\frac{1}{2}$ " 54 x 34mm	No.12

Through Bulkhead Fairlead



Gunmetal	Aperture Dimensions	Overall Size	Bulwark Thickness
2639/GM/110	$2\frac{3}{8}$ " x $1\frac{3}{4}$ " 60mm x 45mm	$4\frac{1}{4}$ " x $3\frac{1}{4}$ " 108mm x 83mm	$1\frac{3}{4}$ " 20mm
2639/GM/145	$3\frac{1}{2}$ " x 2" 88mm x 50mm	$5\frac{5}{8}$ " x $4\frac{1}{8}$ " 142mm x 105mm	$1\frac{1}{4}$ " 32mm



Deck Hardware & Exterior Fittings

Bronze Sheet & Deck Leads

A variety of polished gunmetal leads to guide sheets and control lines along decks, through coamings etc.

Part No. 9405 is based on our fitting from 1936, which we have re-introduced following requests from our customers. Supplied in polished gunmetal, this fairlead can easily be removed when not required and the gunmetal deck plate can also be used to accommodate our ash stand-up blocks on page 33.



Gunmetal	Internal Dia	Width Overall	Height Overall
9405/GM*	5/8" 16mm	2" 50mm	2 1/8" 54mm
9412/GM	5/8" 16mm	2" 50mm	2 1/8" 54mm
9420/GM/50/08	Tapped M8	2" dia. 50mm	7/8" 22mm

*See page 22 for more options

Gunmetal	Internal Dia	Width Overall	Height Overall
9401/GM	1/2" 12mm	1 5/8" 41mm	1 1/2" 38mm
9408/GM/016	5/8" 16mm	2 1/4" 58mm	1" 25mm
9408/GM/018	3/4" 18mm	2 9/16" 60mm	1 1/4" 34mm

Bronze & Lignum Vitae Sheet Leads

Lignum Vitae bullseyes secured with phosphor bronze U-bolts or gunmetal screwdown bindings.



	Binding	Inside Eye Dia.	Dimensions L x W
9402/PB/012	1/4" 6mm Bronze U-Bolt 1 3/4" 44mm Long	1/2" 12mm	2 1/4" x 1 1/8" 58mm x 28mm
9402/PB/016	5/16" 8mm Bronze U-Bolt 2" 50mm Long	5/8" 16mm	2 1/2" x 1 1/4" 64mm x 32mm
9404/GM/012	Screwdown Gunmetal	1/2" 12mm	2 3/8" x 1 1/4" 73mm x 32mm
9404/GM/016	Screwdown Gunmetal	5/8" 16mm	3 1/8" x 1 3/8" 79mm x 34mm

Coaming Leads

These leads, which are cast in gunmetal and then polished, are fitted with brass sheaves. Ideal for passing lines through coamings they are available in single or double format.



Gunmetal	No of Sheaves	Max Rope	Size Overall	Coaming Thickness
9415/GM/012	1	8mm	2 3/4" x 1 5/8" 70 x 41mm	1/2" 12mm
9415/GM/016	1	10mm	3 7/16" x 2" 87 x 50mm	5/8" 16mm
9416/GM/012	2	8mm	4" x 1 1/16" 100 x 40mm	1/2" 12mm
9416/GM/016	2	10mm	5" x 2" 125 x 50mm	5/8" 16mm

Deck Hardware & Exterior Fittings



Fender Eye Plates (Cast)

Available in square or diamond pattern, in barrelled gunmetal, polished gunmetal, and chrome plate finishes.



Square Pattern with 4 fixing holes		Eye Dia	Base Dims	Fastenings
9384/CP	Chrome Plated	3/4"	1 3/4" x 1 1/16"	4 off No. 8
9384/GM	Gunmetal			
9384/GM/POL	Polished Gunmetal			



Diamond Pattern with 2 fixing holes		Eye Dia	Base Dims	Fastenings
9385/CP	Chrome Plated	1/2"	1 1/8" x 1 1/8"	2 off No. 8
9385/GM	Gunmetal			
9385/GM/POL	Polished Gunmetal			

Fender Eye Plates (Stamped)

Available in square pattern stamped brass plates are available in self coloured, polished, and chrome plate finishes.



Diamond Pattern with 2 fixing holes		Eye Dia	Base Dims	Fastenings
BR/SD596-CP	Chrome Plated	5/16"	1 1/8" x 1 1/8"	2 off No. 8
BR/SD596-SC	Brass Self Coloured			
BR/SD596-POL	Polished Brass			

Lacing Hooks and Eyes (Cast)

The low profile pattern is cast in gunmetal and the standard pattern stamped in brass. Both are also available in a chrome plate finish.

Low Profile



	Gunmetal	Chrome	Length	Width	Height
Hook	9502/GM	9502/CP	1 3/4" 45mm	5/8" 16mm	5/16" 8mm
Eye	9504/GM	9504/CP	1 5/8" 41mm	7/16" 11mm	3/8" 9mm

Lacing Hooks, Bridges & Rings (Stamped)

Made in the UK these low profile 'Standard Pattern' are stamped in brass. Both are also available in a chrome plate finish.

Standard Pattern



	Brass	Chrome	Length	Width	Height
Eye	9507/BR	9507/CP	1 3/4" 45mm	5/16" 13mm	1/2" 12mm
Eye	BR/MD374POL	BR/MD374CP	2 1/2" 65mm	1 1/8" 28mm	1" 25mm
Hook	9508/BR	9508/CP	1 1/8" 41mm	5/8" 16mm	7/16" 11mm



Cast Polished Ring Brass 3" OD Polished Round Cross Section 1526/BR/075
 Cast Polished Ring Brass 3 1/2" OD Polished Round Cross Section 1526/BR/090
 Forged Ring Brass 3" OD Self Colour Squared Cross Section BR/MD175/1

Polished Stainless Steel hooks these low profile pattern have a range of applications. The heavy duty one is ideal for large shock cord and ropes.



	Stainless	Length	Width	Height
Hook	BR/SD2432	32mm	7mm	10 mm
Hook	BR/SD2466	66mm	14mm	20 mm



Deck Hardware & Exterior Fittings



Fender Eye Set

Based on the design of a flag clip allows fenders to be removed with out knots.

BR/SD101-102-POL Polished Brass
BR/SD101-102-SC Stamped Finish
BR/SD101-102-CP Chrome Plated

Webbing Retainers in brass

Gunmetal	Length OA	Width Internal	Plate Width	Fastenings
1124/BR/180	3½" 90mm	2" 50mm	½" 13mm	2 off No 8



Engine Control Lever

A simple but well proven engine control lever with an effective twist lock action. Available in polished brass or chrome plated.

Brass	Chrome	Base Dimensions	Height
9626/BR	9626/CP	3½" x 7/8" 90 x 22mm	5" 125mm



Part No	Description	Size
0263/BR	Control Panel Plate takes 1 x ignition key 2 x warning lights and 2 Standard dials	210mm x 128mm No Fixing holes drilled
0263/BR/6+1	Control Panel Strip 6 Switch holes and 1 ignition key hole	40mm x 250mm 2 x Fixing Holes
0263/IGN	4 Position Starter Key Water Proof with 2 keys.	19mm Shaft

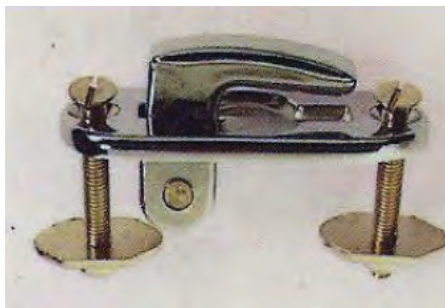

Retractable Hook

A heavy duty hook that can be depressed when not in use. Design to deal with high loads

Brass	Chrome	Base Dimensions	Fastenings
BR/MD176-POL	BR/MD176-CP	2½" x 1 68 x 25mm	High Load Fixings Supplied

Keel or Rubbing Band

Available in brass with feather edge rather than the thicker half round style. Supplied in full lengths only. Not drilled.



Brass	Width	Thickness	Length
5081/BR/010	¾" 10mm	⅛" 3mm	10' 3m
5081/BR/012	½" 12mm	⅛" 3mm	10' 3m
5081/BR/015	⅝" 15mm	⅜" 5mm	10' 3m
5081/BR/019	¾" 20mm	⅜" 5mm	10' 3m
5081/BR/025	1" 25mm	⅜" 5mm	10' 3m



Forged Shackle Plates - High Load

These unique fittings in brass and manganese bronze have an extremely high strength factor, which is forged in during the manufacturing process. Ideal for use as folding pad eyes or binnacle rings, amongst many others, their non-rattle design will give years of reliable and secure service. Available in two sizes in polished finish or chrome plated.

Brass/Manganese Bronze Polished	Chrome	Plate Size	Shackle Size	Approx. Breaking Load
1761/MB/06	1761/CP/06	1 3/8" x 1 3/4" 41 x 45mm	1/4" 6mm	800 kgs
1761/MB/08	1761/CP/08	2 3/8" x 2 3/8" 60 x 60mm	3/16" 8mm	1200 kgs



Forged Ring Bolts - High Load

Brass bolts turned from solid bar and forged manganese bronze shackles combine to provide a unique fitting designed for high loads in the marine environment. Available in two finishes and three sizes up to 2 tonnes breaking load, this range of ring bolts offers security and reliability for many applications on and around the boat.

Brass / Manganese Bronze	Chrome	Bolt Size	Shackle Size	Approx. Breaking Load
1760/MB/10	1760/CP/10	3/8" x 3" 10mm x 75mm	1/4" 6mm	800 kgs
1760/MB/11	1760/CP/11	7/16" x 3 1/2" 11mm x 90mm	3/16" 8mm	1200 kgs
1760/MB/12	1760/CP/12	1/2" x 4" 12mm x 100mm	3/8" 10mm	2000 kgs

Binnacle Rings

Cast in brass.



Brass	Base Size
8781/BR	2 1/2" x 2" 64mm x 50mm

Stanchion Eyebolt/Tensioner

Cast brass eyes with a stainless steel stud



	Stud Length	Stud Dia	Eye Dia
1779/BR	2 3/4" 70mm	3/16" 8mm	1 1/16" 17mm

Bow Eye

A heavy duty cast brass eye complete with stainless steel stud



	Stud Length	Stud Dia	Eye Dia
1780/BR	3" 75mm	3/8" 10mm	1" 25mm

Manganese Bronze Eyebolts



	Shaft Diameter	Shaft Length	Eye I.D.	Breaking Load
1707/MB/08	3/16" 8mm	3 3/8" 78mm	7/16" 11mm	1200kg
1707/MB/10	3/8" 10mm	4" 100mm	1/2" 12mm	1700kg
1707/MB/12	1/2" 12mm	4 1/2" 115mm	1/2" 13mm	2500kg

Ringbolt

Cast in brass and available in brass or chrome plate finish.



Brass	Chrome	Shank dia	Shank Length	Ring ID
0631/BR	0631/CP	3/8" 10mm	2 1/8" 55mm	1 1/4" 32mm
0630/BR	0630/CP	1/2" 12mm	2 3/4" 72mm	1 3/4" 45mm



Bronze Threaded Deck Plates

Cast in gunmetal with a polished finish, these versatile round plates are tapped for three sizes of metric thread, M8, M10 and M12. Ideal for when fitting is not always required or needs to be exchanged for an alternative. Suitable for any item with a metric thread or choose from one of the family of Davey items shown below. Available chromed to special order. More recently made in 316 Stainless Steel with a polished finish.

Part Number Gunmetal	Part Number Stainless	Thread	Diameter x Height	Thread Depth
9420/GM/50/08	9420/SS/50/08	M8	50 x 22mm	15mm
9420/GM/50/10	9420/SS/50/10	M10	50 x 22mm	19mm
9420/GM/66/12	9420/SS/50/10	M12	66 x 34 (GM) 50 x 22mm (SS)	22mm(GM) 19mm (SS)

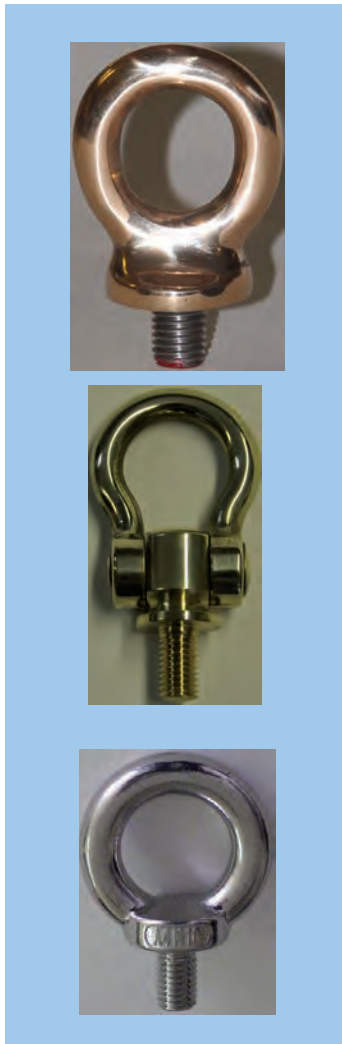

Eye Bolts - Bronze

Three new bronze eye bolts with studs M8, M10 and M12 to suit the deck plates above.

Part Number	Stud	Inside Eye HxW	Total Eye Height
9380/GM/08	M8 x 10mm	22 x 19mm	47mm
9380/GM/10	M10 x 15mm	22 x 19mm	47mm
9380/GM/12	M12 x 20mm	28 x 24mm	58mm

Ring Bolts - Forged

These very strong ring bolts have been especially adapted to suit our deck plates. The bolts are turned from solid brass bar and shackles are forged in manganese bronze.

Part Number	Stud	Shackle Size	Approx Breaking Load
9375/MB/10	M10 x 15mm	¼" 6mm	1200 kg
9375/MB/12	M12 x 20mm	⅜" 10mm	2000 kg

Eye Bolts - Stainless Steel

Three sizes of eye bolts in 316 stainless steel to suit our deck plates. Other sizes available on request.

Part Number	Stud	Eye ID	SWL
9381/SS/08	M8 x 13mm	¾" 20mm	140 kg
9381/SS/10	M10 x 15mm	1" 10mm	230 kg
9381/SS/12	M12 x 20mm	1½" 30mm	340 kg

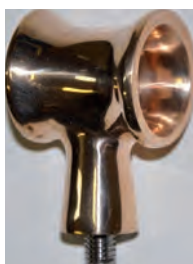

Removable Bronze Sheet Lead (M8)

9405/GM

Bronze Eye Nuts



Part Number	Stud	Inside Eye HxW	Total Eye Height
9380/GM/08/E	M8 x 10mm	22 x 19mm	47mm
9380/GM/10/E	M10 x 15mm	22 x 19mm	47mm
9380/GM/12/E	M12 x 20mm	28 x 24mm	58mm

Deck Hardware & Exterior Fittings



Tiller Fitting

Cast in gunmetal and ready to fit an insert appropriate to your rudder stock.

Gunmetal	Between Straps	Length Overall
1909/GM	1 1/16" 35mm	8" 200mm

Rudder Gear

We have a large selection of rudder gear, in polished gunmetal, to suit a wide range of craft from small dinghies to larger day boats and small cruisers.

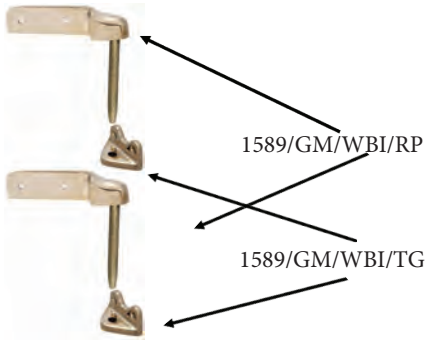

Lightweight Rudder Gear

Available in gunmetal to suit lightweight dinghies up to about 8' long. This item is sold as a set, consisting of two transom gudgeons and two rudder pintles. The rudder pintles have an offset single strap, which can either be fitted to one side of a narrow rudder blade or within a wider one.

Gunmetal	Pintle Diameter	Length of Strap
1589/GM/WBI	5/16" 8mm	2 1/2" 64mm

Wide Gauge Dinghy Rudder Gear

Suitable for the wider rudder, this set is still relatively lightweight and ideal for the heavier, small to medium size dinghy.

Gunmetal	Pintle Diameter	Inside Strap Length		Inside Strap Width
		Gudgeon	Pintle	
1589/GM/MCN	5/16"	4 1/2"	2	1/8"
	8mm	100mm	64mm	

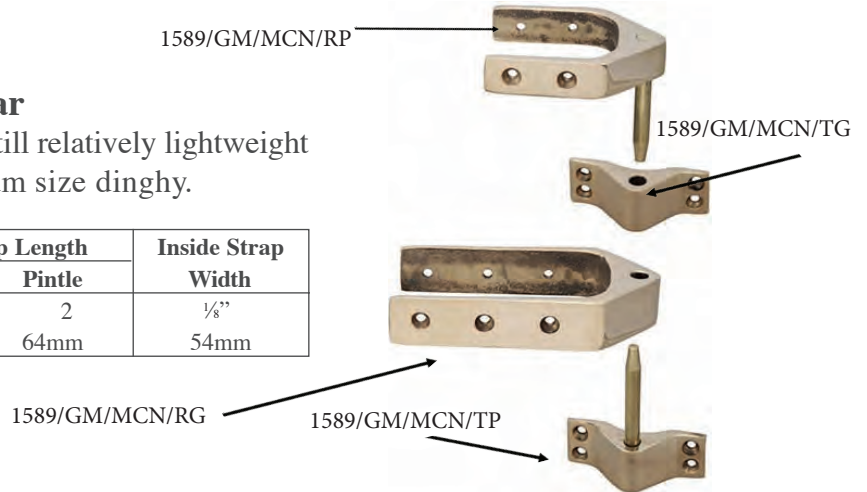

1589/GM019/RP



Standard Duty Rudder Gear 19mm

Sold as a 4-part set or as separate items as shown this is the only rudder set using 7/16 pins.

Gunmetal Set Part No	Pintle Diameter	Inside Strap Length		Inside Strap Width
		Gudgeon	Pintle	
1589/GM/019	7/16" 11mm	7 1/4" 185mm	4 1/4" 105mm	3/4" 19mm

1589/GM019/TG



Transom Plate sizes are 50mm (2") wide and 40mm (1 5/8") High



1589/GM019/RG



1589/GM019/TP





Deck Hardware & Exterior Fittings

Standard Duty Rudder Gear 25/44/56mm

Available in cast and polished gunmetal in three sizes all with 1/2" pins so all use the same Transom fittings. Sold as a 4-part set or individually.



159/GM/025/TG

Transom Plates are 100mm wide by 25mm high

159/GM/025/TP

Gunmetal Set Part No	Pintle Diameter	Inside Strap Length		Inside Strap Width
		Gudgeon	Pintle	
1589/GM/025	1/2" 12mm	7" 175mm	4" 100mm	1" 25mm
1589/GM/044	1/2" 12mm	8 1/4" 210mm	5" 125mm	1 3/4" 44mm
1589/GM/056	1/2" 12mm	6 1/2" 165mm	6 1/2" 165mm	2 3/16" 56mm



1589/GM/025/RP

1589/GM/025/RG



1589/GM/044/RP

1589/GM/044/RG



1589/GM/056/RP

1589/GM/056/RG

Heavy Duty Rudder Gear

Cast in gunmetal for the larger day boat or small cruiser, this range has heavy duty straps and 1/2" pins for additional strength. The rudder gudgeon is canted by approximately 3 degrees.



1917/GM

1919/GM

1918/GM

1920/GM

Part No.	Description	Pintle / Hole Diameter	Between Straps	Inside Strap Length
1917/GM	Rudder pintle	1/2" 12.5mm	2 1/2" 65mm	4" 100mm
1918/GM	Rudder gudgeon	1/2" 12.5mm	2 1/2" 65mm	6" 150mm
1919/GM	Transom gudgeon	1/2" 12.5mm	-	
1920/GM	Transom pintle	1/2" 12.5mm	-	

Dinghy Forged Brass Rudder Gear

This rudder gear is hot forged in the UK which produces strong and accurate fittings ideal for dinghies.



BR/SD482-3-SC

BR/SD482-2-SC

BR/MD228-38-SC

BR/SD696-SC

BR/SD482-1-SC

BR/SD228-32-SC

BPart No	Description	Details
BR/SD482-3-SC BR/SD482-3-CP	Brass Self Colour Gudgeon Chrome Brass Gudgeon	60mm x 60mm with Dia. 10mm Hole 4 x G C/S Screws - Transom Mount
BR/SD482-2-SC BR/SD482-2-CP	Brass Self Colour Gudgeon Chrome Brass Gudgeon	22mm x 60mm with Diam 10mm Hole 2 x G C/S Screws - Transom Mount
BR/MD228-38-SC BR/MS228-38-CP	Brass Self Colour Gudgeon Chrome Brass Gudgeon	26mm High x 120mm Long x 38mm Int. Width 10mm Dia. Hole
BR/SD696-SC BR/SD696-CP	Brass Self Colour Pintle Chrome Brass Pintle	32mm Wide x 63 High with 9mm Dia. Pin Transom Pintle
BR/MD228-32-SC BR/MD228-32-CP	Brass Self Colour Gudgeon Chrome Brass Gudgeon	26mm High x 120mm Long x 32mm Int. Width 10mm Dia. Hole
BR/SD482-1-SC BR/SD482-1-CP	Brass Self Colour Pintle Chrome Brass Pintle	75mm Wide x 85 High with 9mm Dia. Pin Transom Pintle - V Shaped Backing Plate



Bronze Good Fortune Stars

A star on board encourages positive energy. It can make good things better and stops bad things getting worse. These stars are heavy cast bronze and available in three sizes, either polished finish or chrome plated. Supplied in presentation box complete with fixing screw.



Part No.	Part No.	Radius	Span	Thick
9526/GM/030	9526/CP/030	1 1/4" 30mm	2" 52mm	5/16" 8mm
9526/GM/040	9526/CP/040	1 1/2" 40mm	3" 75mm	3/8" 9.5mm
9526/GM/050	9526/CP/050	2" 50mm	3 1/4" 95mm	7/16" 11mm

Straight Flag Sockets



Part No.	Staff Dia	Base Dia	Height	Fastenings
9570/GM/019	3/4" 19mm	2 1/2" 65mm	3" 75mm	3 off No 8
9570/GM/025	1" 25mm	2 1/2" 65mm	3" 75mm	3 off No 8

Raked Flag Sockets



9571

9576

Gunmetal	Staff Dia	Base Dia	Height	Fastenings
9571/GM/019	3/4" 19mm	2 1/4" 58mm	2 1/2" 65mm	4 off No. 8
9571/GM/025	1" 25mm	2 1/2" 63mm	2 3/4" 70mm	4 off No. 8
9571/GM/031	1 1/4" 31mm	3" 75mm	2 3/4" 70mm	4 off No. 10
9576/GM/031	1 1/4" 31mm	3 1/2" 90mm	3 1/4" 82 mm	4 off No. 10

Note: The 9576 is a heavy duty fitting with a greater degree of rake being 30 degrees from vertical compared to the 9571 which is 20 degrees from vertical.

Raked with Cleat and Button



9575

Gunmetal	Staff Dia	Base Dia	Height	Fastenings
9575/GM/025	1" 25mm	3" 75mm	2 1/4" 70mm	4 off No. 8
9575/GM/031	1 1/4" 31mm	3 1/2" 90mm	3 3/8" 78mm	4 off No. 10
9575/GM/037	1 1/2" 38mm	3 3/4" 95mm	3 1/2" 90mm	4 off No. 10

Dutch Style



9567

9568

9569

Gunmetal	Type	Base Dia	Height	Fastenings
9567/GM	Upright	1 1/4" 34mm	7 1/4" 198mm	3 off No. 8
9568/GM	Raked	1" 25mm	5 3/4" 145mm	3 off No. 8
9569/GM	Raked	1 1/4" 34mm	7 1/4" 198mm	3 off No. 8

Boom Crutch Sockets (Wooden Supports not included)



9591

9595

Gunmetal	Chrome	Base Dims.	Inside Dims.
9591/GM	9591/CP	5 3/8" x 2 3/4" 137 x 68mm	2 1/2" x 1" 64 x 24mm
9595/GM	9595/CP	2 1/2" x 1 3/8" 63 x 34mm	2 3/8" x 1" 58 x 25mm



Deck Hardware & Exterior Fittings



Oar Clamp

A very useful device for securing your oars to the dinghy when it is left unattended. A hole is drilled through the thwart and the clamp passes through gripping the oars under its arms, a padlock then secures everything in place under the thwart. An optional socket is available to finish the hole neatly. Cast in bronze and polished.

Part No. 1055/GM Oar Clamp
Part No. 1055/GM/SKT Optional Socket



Stemhead Fitting

Cast in gunmetal with a polished finish, this strong stemhead fitting takes the load down the front of the stem and is suitable for craft up to around 18 foot.

Gunmetal	Inside Length	Inside Angle	Width	Height Above Stem
3727/GM	6" 150mm	85 degrees	1" 25mm	1 1/16" 34mm

Lightweight Stemhead Fitting

Cast in gunmetal this stemhead fitting is suitable for dinghies up to around 12 foot.

Gunmetal	Length	Front Strap	Width
3729/GM	4 1/2" 110mm	2 1/2" 60mm	3/4" 20mm

Side Fitting Stemhead Roller

Available in polished gunmetal to suit chain from 1/4" to 3/8". The outer cheek curves inwards to help chain retention. Now supplied with axle bolt for extra security.

Gunmetal	Length	Width	Chain Size	Roller Size	Bolt Size
1108/GM/08	6 1/2" 156mm	2" 50mm	5/16" 8mm	2" x 1 1/2" 50 x 38mm	3/8" x 7" 10 x 175mm
1108/GM/10	7 7/8" 183mm	2 1/2" 62mm	3/8" 10mm	2 1/2" x 1 3/4" 62 x 44mm	1/2" x 8" 12 x 200mm

Centre Fitting Stemhead Roller

Cast in gunmetal this fitting will suit a wide variety of foredecks. The base of the larger size has a small lip to the front.

Gunmetal	Roller Size	Base Length	Base Width
1125/GM/06	1 1/4" x 1 1/4" 45 x 32mm	4 1/2" 110mm	3 3/8" 75mm
1125/GM/08	2" x 1 1/2" 50 x 38mm	4" 100mm	3 3/4" 95mm

Heavy Duty Bow Roller

Cast in gunmetal this fitting will suit a wide variety of foredecks. Designed for Fastening through the deck - Roller Bronze. Drilled for a top retaining pin (not supplied).

Part No	Length Over All	Roller Size	Over Hang	Base Plate Width
1123/GM	10" 250mm	45mm dia x 33mm w	4" 100mm	4 1/4" 108mm

Deck Hardware & Exterior Fittings



Anchor Chocks



These universal anchor chocks can be used with a wide range of anchors. These can be configured in any layout to suit the requirements and size of the anchor you have.

Bought as a set or as individual components to suite your needs. Manufactured in Gunmetal and polished finish. Can be chromed on request.

Part No	Description	Size	Fasteners
2510/GM/SET	1 off A, 2 off B, 1 off C, 1 off D	See Below	10 off No 10
2510/GMA	Rest & Retainer for Shank	18mm X 92mm	2 off No 10
2510/GM/B	Retain Loops for tie Down	20mm X 66mm	2 off No 10
2510/GM/C	Anchor Toe Chock	55mm X 55mm	2 off No 10
2510/GM/D	Anchor Heel Chock	48mm X 88mm	2 off No 10

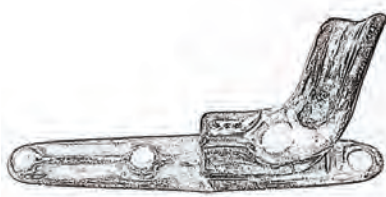

NEW PRODUCT - Sprit Roller

This is a new product which was not back in time for the catalogue. This is a sketch of the item. Made in Polished gunmetal and is designed to mount on the Starboard side of the sprit only

Part No	Length Over All	Height Overall	Roller Size	Plate Width
1127/GM	267mm	100mm	Dia 75mm x 30mm	40mm



Chain Pipes

Gunmetal	Internal Dia		Height		Chain Size	
2633/GM/037	1½"	38mm	¾"	83mm	¼"	6mm
2633/GM/044	1¾"	44mm	3½"	92mm	⅝"	8mm
2633/GM/050	2"	50mm	4"	100mm	⅜"	9.5mm
2633/GM/062	2½"	64mm	4½"	114mm	⅞"	11mm
2633/GM/075	3"	75mm	5¼"	133mm	1"	14mm

Brass Dinghy Anchor



Made in the UK - this Fishermans style anchor is quick to assemble and use, but packs away to a very small foot print. Made in brass with wide flukes to ensure good holding. This is ideal for Dinghy's.

Part No	Description	Weight	Length OA	Stock Width	Folded Width
BR/LD111/SC	Self Coloured Brass Anchor	1.5 KG	13" 325mm	320mm	3" 75mm Max
BR/LD111/CP	Chrome Plated Anchor	1.5 KG	13" 325mm	320mm	3" 75mm Max

Brass/Chrome Plated Captive Rowlocks



Made in the UK - these captive rowlocks are forged from high grade brass and then supplied chrome plated as a pair. This means loosing rowlocks over board can be a thing of the past. They fold back on a double fold stem. This means they do not hit the side of the boat when not in use. NOTE - Sold As Pairs

Part No	Description	Jaw Width	Stem Diameter	Plate Length x depth
BR/MD174/SC	Self Coloured Brass Captive Rowlock	2" 51mm	14.3mm	62mm x 25mm
BR/MD174/CP	Chrome Plated Captive Rowlock	2" 51mm	14.3mm	62mm x 25mm
BR/MD174/POL	Polished Captive Rowlock	2" 51mm	14.3mm	62mm x 25mm



Deck Hardware & Exterior Fittings

We have a wide variety of galvanised and gunmetal rowlocks to suit most rowing craft. All come complete with sockets, which we also list separately for ordering as spares or additions. Please note that we supply rowlocks as singles, not as pairs.

Gunmetal Rowlocks



1066 & 1040 Set



1049 Set
Even Tops



1910/GM



1066/GM/SKT



1051/GM

Gunmetal rowlocks are a delightful addition to any fine rowing craft. It should be noted however that as this is a softer material it is not suitable for heavy rowing. If additional strength is required, moving up to a larger size would be worth considering.

	Jaw Width		Stem Diameter	
1066/GM/45	1 3/4"	45mm	7/16"	11mm
1066/GM/50	2"	50mm	1/2"	12mm
1040/GM	2 1/2"	62mm	5/8"	16mm
1049/GM/50	2"	50mm	1/2"	12mm

Above sold as Sets - 1 x Rowlock 1 x Socket

Rowlocks only add ROW to then end of the part number

Extra Sockets

Top Mount Socket	Side Mount Socket	Stem Diameter	
1066/GM/50/SK	1051/GM	1/2"	12mm
1040/GM/SKT	-	5/8"	16mm
-	1910/GM	1/2"	12mm

1066/GM/45/SKT for 7/16" available as well

Galvanised Rowlocks



1042 Ordinary Pattern



1049 Even Top

	Jaw Width		Stem Diameter	
1042/GA/50/10	2"	50mm	3/8"	10mm
1042/GA/50/12	2"	50mm	1/2"	12mm
1042/GA/75/19	3"	75mm	3/4"	19mm

Above sold as Sets - 1 x Rowlock 1 x Socket

Galvanised Even Top Rowlocks - Sold as 1 x Rowlock 1 x Plate				
1049/GA/50/12	2"	50mm	1/2"	12mm



1051/GA



1057

Captive Rowlocks

1057/GA/50/12	2"	50mm	1/2"	12mm
---------------	----	------	------	------

Sold individually

Side Mount Sockets

- 1051/GA/10 - For 3/8" stem
- 1051/GA/11 - For 7/16" stem
- 1051/GA/12 - For 1/2" stem



Bronze Stanchions

Cast in gunmetal and with a polished finish, these tapered stanchions are 27mm at the base and are available in three heights. A choice of three styles of socket are available to suit.

Stanchions	
Gunmetal	Height
1655/M/500	19½" 500mm
1655/GM/625	24½" 625mm
1655/GM/750	29½" 750mm

Bronze Stanchion Bases

We offer 3 styles of bases in polished gunmetal to suit the 1655 stanchions.



Surface mount deck base with arm and securing pin hole. Height: 2½ 65mm
Part No. 1657/GM



Flush base with securing screw to prevent stanchion jumping out. Diameter: 2¾" 69mm
Depth: 2¼" 54mm
Part No. 1658/GM



Side mounting socket for attaching to the gunwhale or other vertical surfaces. This keeps the deck clear and allows for some height adjustment. Height: 5" 69mm
Width: 3" 54mm
Part No. 1659/GM



Bronze Stanchions with Fixed Base

Cast in one piece, this polished bronze stanchion has a round base and ball top for a single wire. The round base has 4 countersunk fixing holes.

Part No.	Height	Base Diam
1652/GM	18" 457mm	3" 75mm

Handrail Stanchions

Cast in brass with a choice of styles. All types can be supplied chrome plated to special order.



Open	Closed	Rail Diameter	Base Dia	Height	Fastenings
1663/BR/31	1664/BR/31	1¼" 32mm	2¼" 58mm	2¼" 70mm	4 off No. 10
1663/BR/37	1664/BR/37	1½" 38mm	2¼" 58mm	3" 78mm	4 off No. 10

Lighter Pattern



Open	Closed	Rail Diameter	Base Dia	Height	Fastenings
0470/BR	0471/BR	1⅞" 30mm	2⅞" 67mm	2¾" 70mm	3 off No. 8

Boat Badge

The finishing touch for a small dinghy or launch, this badge is sandblasted ready for painting. Traditionally, the hollow centre would frame a miniature picture of the club or owners burgee.



	Outside Oval	Inside Oval
9525/BR	5½" x 4½" 138mm x 110mm	3½" x 2½" 90mm x 65mm



Deck Hardware & Exterior Fittings

Boathooks and Staves

Boathook ends are cast in gunmetal with a polished finish.



1000



1001



1018

Gunmetal	Length	Stave Dia
1000/GM	6" 150mm	1/4" 32mm
1001/GM/200	8" 200mm	1/2" 38mm
1001/GM/250	10" 250mm	1/2" 38mm
1018/GM/150	6" 150mm	1/4" 32mm
1018/GM/200	8" 200mm	1/2" 38mm



'Grabit' Boathook

The original, and still the best boathook for attaching a line to a mooring buoy or ring. Cast in aluminium bronze, which is as tough as steel, one sweep with the grabit leaves the boat secure whilst a permanent mooring is attached.

Part No	Length	For Stave Dia.
1025/AB/250	10" 250mm	1/2" 38mm

Boathook Staves

Made from the finest quality ash, one end is rounded and the other is left plain for fitting to the boathook head.

	Length	Diameter		Length	Diameter
1012/OO/1800/28	6" 1800mm	1/8" 29mm	1012/OO/3000/37	10" 3000mm	1/2" 38mm
1012/OO/1800/32	6" 1800mm	1/4" 32mm	1012/OO/3600/37	12" 3600mm	1/2" 38mm
1012/OO/2400/32	8" 2400mm	1/4" 32mm	1012/OO/4200/37	14" 4200mm	1/2" 38mm
1012/OO/2400/37	8" 2400mm	1/2" 38mm	1012/OO/4800/37	16" 4800mm	1/2" 38mm
1012/OO/3000/32	10" 3000mm	1/4" 32mm			



Complete Set

Boarding Ladder Set

4 piece set in polished bronze with optional hinges and spare eyes.

Part No.	Item
9622/GM/SET	Complete Set
9622/GM/E	Spare Eyes
9622/BR/H	Brass Hinges



Spare Eye



Rail Hinge Cast in gunmetal and polished.

Gunmetal	To suit rail size
8956/GM/082	3/4" x 1/4" 82mm x 4mm
8956/GM/094	3/4" x 1/2" 95mm x 8mm





Wykeham Martin Furling Gear

In continuous production for over 100 years, this traditional furling gear has been successfully fitted to thousands of boats worldwide. Cast in bronze from the original patterns, the parts are carefully machined, polished and assembled by English craftsmen to produce a beautiful and efficient furling system. Fitted with stainless steel thrust races to ensure free running and easy sail furling. An information leaflet is available on request. Service kits available.



Dimensions in mm's

Top Swivel	Drum	Size	Approx. Sail Area		A	B	C	D	E
			sq. ft	sq. m					
9443/GM/01/TS	9443/GM/01/DR	1	50	5	72	10	eye	85	62
9443/GM/2B/TS	9443/GM/2B/DR	2B	100	10	100	18	11	128	85
9443/GM/3B/TS	9443/GM/3B/DR	3B	200	20	110	20	12	135	95
9443/GM/4B/TS	9443/GM/4B/DR	4B	350	35	150	28	16	165	150

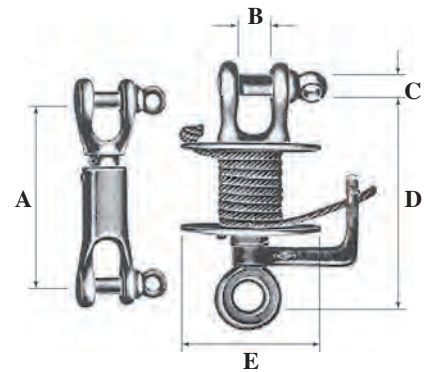

Highfields Pattern Running Backstay Lever

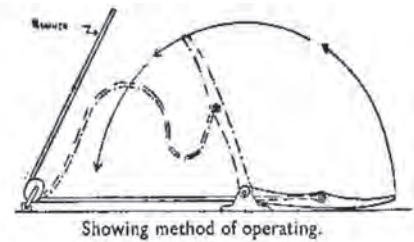

Lever	Size No	Wire	Lever Length		Base Size	
2655/GM/01	1	6mm	10"	250mm	3 3/4" x 1 3/8"	95 x 35mm
2655/GM/02	2	8mm	16"	406mm	5" x 1 1/4"	125 x 46mm
2655/GM/03	3	10mm	23 1/2"	597mm	7 3/4" x 2 3/8"	196 x 67mm

Sliding Gooseneck

This all brass dinghy fitting consists of a spike on a gooseneck with tangs and thumb screw for adjustment. Supplied with 12" (300mm) of brass internal track, size 3/8" (16mm).

Part No. 3401/BR



Halfband & Spike

Cast in gunmetal. Works with the Davey boom fittings



Gunmetal	Jaw width	
3402/GM/050	2"	50mm
3402/GM/062	2 1/2"	62mm
3402/GM/075	3"	75mm
3402/GM/087	3 1/2"	87mm



Rigging & Sail Handling

Tack



Clew



Boom Fittings

Tack and clew fittings cast in gunmetal. The clew fitting has a double swivel tang, and the tack has a square hole for use with roller reefing.

Part No	Description	Diameter	
9446/GM/T/050	Tack Boom End Fitting	2"	50mm
9446/GM/C/050	Clew Boom End Fitting	2"	50mm



Bronze Reefing Claw

Cast in aluminium bronze, which is a very tough alloy, this product is particularly suited to its purpose, being very stiff and strong yet without excessive bulk.

Part No	Inside Diameter	
9447/AB/100	4"	100 mm
9447/AB/125	5"	125 mm



Parrel Beads

Turned from Ash and treated with Linseed Oil.

Part No.	Length x Diameter		Bore
0924/00/0227	1/8" x 7/8"	22 x 22mm	6mm
0924/00/035	1 1/8" x 1 1/8"	35 x 28mm	8mm
0924/00/044	1 3/4" x 1 3/8"	44 x 35mm	10mm
0924/00/050	2" x 1 1/8"	50 x 42mm	12mm
0924/00/070	2 3/4" x 2 1/16"	70 x 55mm	18mm

Bronze Shroud and Bowsprit Plates

To ensure correct positioning of the plates to the vessel, these products are now supplied undrilled, thus allowing the fitter to drill fixing holes that correspond to the boats strong points.

9471



9472



Gunmetal	Type	Length Overall	
9471/GM/075	Shroud plate	3"	75mm
9471/GM/100	Shroud plate	4"	100mm
9471/GM/150	Shroud plate	6"	150mm
9471/GM/200	Shroud plate	8"	200mm
9471/GM/250	Shroud plate	10"	250mm
9471/GM/300	Shroud plate	12"	300mm
9471/GM/400	Shroud plate	16"	400mm
9472/GM/100	Bowsprit plate	4"	100mm
9472/GM/150	Bowsprit plate	6"	150mm
9472/GM/200	Bowsprit plate	8"	200mm
9472/GM/250	Bowsprit plate	10"	250mm
9472/GM/300	Bowsprit plate	12"	300mm

Mast Bands

Cast in gunmetal, they are available with either two or four eyes.



Gunmetal	No of Eyes	Internal dia.	
3416/GM/038	2	1 1/2"	38mm
3416/GM/050	2	2"	50mm
3416/GM/062	2	2 1/2"	62mm
3416/GM/075	2	3"	75mm
3416/GM/087	2	3 1/2"	87mm
3416/GM/100	2	4"	100mm
3418/GM/050	4	2"	50mm
3418/GM/062	4	2 1/2"	62mm
3418/GM/075	4	3"	75mm
3418/GM/087	4	3 1/2"	87mm
3418/GM/100	4	4"	100mm



Belaying Pins

Available in gunmetal, brass and turned ash.



Gunmetal	Brass	O.A. Length	Stem Length	Stem Diameter
-	1634/BR/156	6¼" 158mm	3¾" 95mm	⅜" 10mm
-	1634/BR/187	7½" 190mm	4½" 114mm	½" 12mm
1634/GM/231	-	9¼" 235mm	5" 125mm	⅝" 16mm
1634/GM/300	-	12" 300mm	7" 175mm	⅞" 18mm
1634/GM/350	-	14" 350mm	8¼" 210mm	1⅜" 20mm

Ash	O.A. Length	Stem Length	Stem Diameter
1635/AH/217	6¼" 158mm	3¾" 95mm	⅜" 10mm
1635/AH/266	7½" 190mm	4½" 114mm	½" 12mm
1635/AH/310	9¼" 235mm	5" 125mm	⅝" 16mm
1635/AH/337	12" 300mm	7" 175mm	⅞" 18mm
1635/AH/365	14" 350mm	8¼" 210mm	1⅜" 20mm

Gaff Span Shackles

Available in gunmetal.



Gunmetal	Jaw Width	Pin Diameter	Length
1227/GM/06	¼" 6mm	⅝" 8mm	2" 50mm
1227/GM/10	⅜" 10mm	⅜" 10mm	2½" 64mm
1227/GM/12	½" 12mm	7⁄16" 11mm	2⅞" 75mm
1227/GM/16	⅝" 16mm	½" 12mm	3⅝" 93mm

Stamped Brass Snap Shackles



Fixed Eye	Length	s.w.l. kg	Swivel Eye	Length	s.w.l. kg
3435/MB/031	1¼" 32mm	100	3439/MB/057	2¼" 57mm	180
3435/MB/041	1⅝" 41mm	150	3439/MB/069	2¾" 70mm	300
3435/MB/050	2" 50mm	250	3439/MB/081	3¼" 81mm	400
3435/MB/062	2½" 62mm	350	3439/MB/100	4" 100mm	480
3435/MB/075	3" 75mm	500	3439/MB/137	5½" 139mm	1000
3435/MB/100	4" 100mm	1000	-	-	-

Manganese Bronze Shackles



Dee	Approx Break Strain	Harp	Approx Break Strain	Pin Dia	Shackle Dia.
1219/MB/03	400kg	-	-	3mm	3mm
1219/MB/04	500kg	-	-	4mm	4mm
1219/MB/05	600kg	1218/MB/05	400kg	5mm	5mm
1219/MB/06	1000kg	1218/MB/06	800kg	6mm	6mm
1219/MB/08	1600kg	1218/MB/08	1200kg	8mm	8mm
1219/MB/10	2400kg	1218/MB/10	1600kg	10mm	10mm

Pelican Hook

Cast in gunmetal and polished. 4" (100mm) long overall.
Part No. 1390/GM





Rigging & Sail Handling

Track and Slides

Our track is extruded from brass and supplied in undrilled lengths of approx. 3 mtrs (10 foot). The slides are formed from brass sheet or cast in gunmetal and polished.

Internal Track and Slides

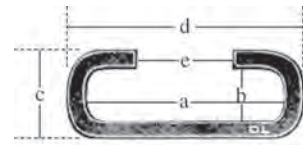
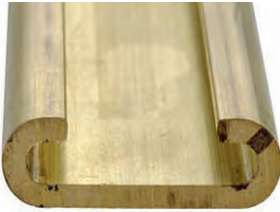

Brass	Nominal Size (a)	b	c	d	e	
1321/BR/T/16	5/8"	16mm	3.25mm	8mm	21mm	9mm
1321/BR/T/19	3/4"	19mm	3.5mm	8mm	25mm	13.5mm
1321/BR/T/25	1"	25mm	5.5mm	12mm	31mm	12.5mm



Brass	Size	
1320/BR/S/16	5/8"	16mm
1320/BR/S/19	3/4"	19mm

Part No	Material	Length	Width
BR/SD481	Brass	34mm	16mm
1321/GM/19	Gunmetal	32mm	19mm
1321/GM/25	Gunmetal	38mm	25mm



Brass	Size	
1296/BR/T/16 ^s	5/8"	16mm
1296/BR/T/19 ^s	3/4"	19mm

External Track and Slides



Brass	Size	
1296/BR/S/16 ^s	5/8"	16mm
1296/BR/S/19 ^s	3/4"	19mm



Hatch Slides

Our 3/4" brass tracks, 1296/BR/T/19 and 1321/BR/T/19, mate perfectly together to provide secure, smooth running hatch sliding gear.



Sliding Decklead

Cast in gunmetal with a polished finish, this decklead fits the 1" (25mm) internal track. and has a knurled thumb screw to secure it at any point of its travel.

Part No. 3446/GM/025



Spinnaker Pole Slide

Cast in gunmetal with a polished finish, this spinnaker pole slide fits the 1" (25mm) internal track. A knurled thumb screw locks it at the desired position.

Part No. 3443/GM/025

Spinnaker Pole End

Polished gunmetal end socket to fit to a wooden spar. Sprung piston end.

Gunmetal	Strap Length	Spar Diameter
3422/GM/100	4" 100mm	1 3/4" 45mm
3422/GM/125	5" 125mm	2 1/4" 58mm





Davey Ash Blocks

Inspired by our 1928 range, we have carefully developed these blocks to have the right proportions for the efficient use with ropes from 8mm to 14mm. They are strong, simple and functional but at the same time have the beauty and elegance to enhance the finest of craft.

Key Features

- Bindings: Heavy gauge stainless steel - internal. Fixed and swivel head.
- Sheaves: Tufnol type material as standard, aluminium bronze as an option.
- Bearings: Plain on oversized SS spindles to spread the load and ensure smooth running.
- Shell: High quality ash, formed into a smooth oval shape and varnished.
- Maintenance: By removing just one machine screw the block can easily be disassembled for inspection and maintenance without damaging the wooden shell.
- Appearance: Just beautiful!

Sizing Table

Shell Length	Rope Size	Sheave Diameter	SWL Kg
3" 75mm	8 - 10	40	1500
3½" 88mm	10 - 12	50	1750
4" 100mm	12 - 14	60	2000



Fixed Eye Head

Block Type	3" 75mm	3½" 88mm	4" 100mm
Single	0610/AH/075	0610/AH/088	0610/AH/100
Single & Becket	0611/AH/075	0611/AH/088	0611/AH/100
Double	0612/AH/075	0612/AH/088	0612/AH/100
Double & Becket	0613/AH/075	0613/AH/088	0613/AH/100

Note: Triple blocks are also available to special order



Fiddle Blocks with Fixed Eye

Block Type	7" 175mm	8" 206mm
	10 - 12mm Rope	12 - 14mm Rope
Without Becket	0614/AH/175	0614/AH/206
With Becket	0615/AH/075	0615/AH/206



Strop Blocks

Block Type	3" 75mm	3½" 88mm	4" 100mm
Single	0617/AH/075	0617/AH/088	0617/AH/100



Rigging & Sail Handling



Swivel Head

Block Type	3" 75mm	3½"88mm	4" 100mm
Single	0620/AH/075	0620/AH/088	0620/AH/100
Single & Becket	0621/AH/075	0621/AH/088	0621/AH/100
Double	0622/AH/075	0622/AH/088	0622/AH/100
Double & Becket	0623/AH/075	0623/AH/088	-



Single Stand-up Blocks

These blocks consist of a swivel block together with a stainless steel eyebolt and spring assembly

	3" 75mm	3½"88mm	4" 100mm
Eye Bolt Size	M8 x 60mm	M8 x 60mm	M10 x 60mm
Single	0624/AH/075	0624/AH/088	0624/AH/100



Stand-up Kits - Stainless Steel

These kits, comprising of an eye bolt, 2 pressure plates and a spring, can be ordered to convert any of our swivel ash blocks to stand up.

For Block Size	3" 75mm	3½"88mm	4" 100mm
Eye Bolt Size	M8 x 60mm	M8 x 60mm	M10 x 60mm
Part Number	0625/SS/075	0625/SS/088	0625/SS/100



Tackle Hooks - Stainless Steel 316

Useful and versatile hooks with many applications on board. Available in 3 sizes. 8mm, 10mm and 12mm.

Part Number	Nominal Size	Overall Length	Eye ID
1395/SS/08	8mm	3½" 81mm	⅝" 14mm
1395/SS/10	10mm	4¼" 110mm	¾" 20mm
1395/SS/12	12mm	5¼" 135mm	1" 25mm



Sheaves Only

Sheaves are available separately as spares in the normal tufnol type material and also in aluminium bronze for upgrading or other uses.

Size Dia. x Width x Bore	Tufnol Type Sheave	Aluminium Bronze Sheave
40 x 12 x 10	0619/OO/040	0619/AB/040
50 x 14 x 12	0619/OO/050	0619/AB/050
60 x 16 x 12	0619/OO/060	0619/AB/060

All the blocks in this range are available in teak to special order - minimum quantities will apply.



Large Ash Blocks

Built to the same high standard, and similar construction method, as our smaller ash blocks but with larger ash shells in relation to the rope size, for use with larger craft. The high strength is derived from the heavy gauge stainless steel bindings and oversized spindles, on which the hard wearing ertalon sheaves run smoothly. The blocks are supplied varnished and suit ropes up to 26mm.

Single Block

Part No	Shell Length	Rope Size mm	Sheave Size mm	SWL kg
0650/AH/160	6 ⁵ / ₁₆ " 162mm	16 - 18	90	4600
0650/AH/160	7 ³ / ₄ " 197mm	20 - 22	112	6000
0650/AH/160	8 ³ / ₄ " 224mm	24 - 26	146	6750

Single Block & Becket

Part No	Shell Length	Rope Size mm	Sheave Size mm	SWL kg
0651/AH/160	6 ⁵ / ₁₆ " 162mm	16 - 18	90	4600
0651/AH/200	7 ³ / ₄ " 197mm	20 - 22	112	6000
0651/AH/225	8 ³ / ₄ " 224mm	24 - 26	146	6750

Double Block

Part No	Shell Length	Rope Size mm	Sheave Size mm	SWL kg
0652/AH/160	6 ⁵ / ₁₆ " 162mm	16 - 18	90	8850
0652/AH/200	7 ³ / ₄ " 197mm	20 - 22	112	12350
0652/AH/225	8 ³ / ₄ " 224mm	24 - 26	146	13500

Double Block & Becket

Part No	Shell Length	Rope Size mm	Sheave Size mm	SWL kg
0653/AH/160	6 ⁵ / ₁₆ " 162mm	16 - 18	90	8850
0653/AH/200	7 ³ / ₄ " 197mm	20 - 22	112	12350
0653/AH/225	8 ³ / ₄ " 224mm	24 - 26	146	13500

Triple Block

Part No	Shell Length	Rope Size mm	Sheave Size mm	SWL kg
0654/AH/160	6 ⁵ / ₁₆ " 162mm	16 - 18	90	8850
0654/AH/200	7 ³ / ₄ " 197mm	20 - 22	112	12350
0654/AH/225	8 ³ / ₄ " 224mm	24 - 26	146	135250

Triple Block & Becket

Part No	Shell Length	Rope Size mm	Sheave Size mm	SWL kg
0655/AH/160	6 ⁵ / ₁₆ " 162mm	16 - 18	90	8850
0655/AH/200	7 ³ / ₄ " 197mm	20 - 22	112	12350
0655/AH/225	8 ³ / ₄ " 224mm	24 - 26	146	135250

Bronze Blocks

Traditional all metal block with a polished cast bronze shell and eye fitted with a turned brass sheave.

Without Becket	With Becket	Rope Size	Sheave Diameter	Shell Length
0500/GM/037	-	6mm	7/8"	1 1/2"
0500/GM/050	0501/GM/050	8mm	1 1/4"	2"



Also available to special order A wide range of blocks in different styles sizes and finishes



Rigging & Sail Handling

Wooden Blocks with Roller Bearings

Manufactured in ash or teak with stainless steel bindings, these blocks have brass sheaves with roller bearings. Also available in larger sizes for ropes up to 20mm.

Single Block



Teak	Ash	Rope Size	Shell Length	Sheave Size	Breaking Load daN
0580/TK/060	0580/AH/060	10mm	60mm	30 x 12mm	1000
0580/TK/070	0580/AH/070	12mm	70mm	35 x 14mm	1300
0580/TK/080	0580/AH/080	14mm	80mm	40 x 16mm	2000
0580/TK/105	0580/AH/105	18mm	105mm	55 x 20mm	2200
0580/TK/120	0580/AH/120	20mm	120mm	65 x 22mm	2500



Single Block and Becket

Teak	Ash	Rope Size	Shell Length	Sheave Size	Breaking Load daN
0581/TK/060	0581/AH/060	10mm	60mm	30 x 12mm	1000
0581/TK/070	0581/AH/070	12mm	70mm	35 x 14mm	1300
0581/TK/080	0581/AH/080	14mm	80mm	40 x 16mm	2000



Double Block

Teak	Ash	Rope Size	Shell Length	Sheave Size	Breaking Load daN
0582/TK/060	0582/AH/060	10mm	60mm	30 x 12mm	1000
0582/TK/070	0582/AH/070	12mm	70mm	35 x 14mm	2000
0582/TK/080	0582/AH/080	14mm	80mm	40 x 16mm	2000



Double Block and Becket

Teak	Ash	Rope Size	Shell Length	Sheave Size	Breaking Load daN
0583/TK/060	0583/AH/060	10mm	60mm	30 x 12mm	1000
0583/TK/070	0583/AH/070	12mm	70mm	35 x 14mm	2000
0583/TK/080	0583/AH/080	14mm	80mm	40 x 16mm	2000

THIS RANGE OF BLOCKS CAN BE SUPPLIED FOR 18mm AND 20mm ROPE TO ORDER.



ALSO AVAILABLE IN TRIPLES TO ORDER



Gunmetal Snatch Blocks

These snatch blocks consist of a swivel snap shackle with gunmetal cheeks and with polished stainless steel bindings. A practical yet traditional feel snatch block with Ertalyte sheaves.

Part No	Description	Sheave Dia.	Sheave Width	Rope Dia.	SWL	Length
0551/GM/035	Snatch Block 35mm With SS s Snap Shackle.	35mm	17mm	12mm	400KG	110mm
0551/GM/048/SN	Snatch Block 48mm With SS Snap Shackle.	48mm	20mm	16mm	550KG	150mm
0551/GM/048/D	Snatch Block 48mm With Stainless Dee Shackle	48mm	20mm	16mm	650KG	144mm

0656 - Ash Snatch Blocks to order



Foot/Sheet Blocks

These blocks consist of a two polished brass faces and three hollow stainless steel rivets to allow through bolting to the deck or super structure. Cam and end supports made in Gunmetal. Backing plates below decks are recommended. Available with locking cam or as a standard foot block in two sizes.

Part No	Description	Sheave Dia.	Sheave Width	Max Rope Dia.	SWL (KG)	Length	Fixings
9456/BR/50	Foot Block 50mm without cam in polished brass.	50mm	15mm	12mm	500	79mm	3x M6 Bolts
9456/BR/50/LCK	Foot Block 50mm with locking cam in polished brass.	50mm	15mm	12mm	500	84mm	3 x M6 Bolts
9456/BR/65	Foot Block 65mm without cam in polished brass.	65mm	18mm	16mm	800	100mm	2 x M6 Bolts 1 x M8 Bolt
9456/BR/65/LCK	Foot Block 65mm with locking cam in polished brass.	65mm	18mm	16mm	800	105mm	2 x M6 Bolts 1 x M8 Bolt

Manganese Bronze Rigging Screws

British made and available in Self Colour (SC) or Chrome Plated (CP) finish, these turnbuckles are compact and strong. Available with metric or imperial threads these are compact and easy to adjust.

Part No	Finish	Ends Option	Thread Size	Fork Width	Open Length (Pin Centres)	Closed Length (Pin Centres)	Aprox. Break Load (KG)	Locking Method
BR/SD424	CP or SC	FE or FF or EE	0BA	5/32"	4 1/8"	3 1/8"	500	Knurled Nut
BR/SD523	CP or SC	FE or FF or EE	5/16 BSF	3/16"	5"	3 3/4"	1000	Knurled Nut
BR/SD550	CP or SC	FE or FF or EE	3/8 BSF	3/8"	8 1/4"	6"	2000	Hex Nut
BR/SD560	CP or SC	FE or FF or EE	7/16 BSF	7/16"	10 1/4"	7 1/2"	3000	Hex Nut
BR/SD1004	CP or SC	EE	4mm	N/A	105mm	80mm	400	Hex Nut
BR/SD1006	CP or SC	EE or TE or TT	6mm	6mm	150mm	115mm	1000	Hex Nut
BR/SD1008	CP or SC	EE or TE or TT	8mm	8mm	205mm	160mm	1700	Seizing wire/Pins
BR/SD1010	CP or SC	EE or TE or TT	10mm	10mm	245mm	185mm	2500	Seizing wire/Pins



FE = Fork Eye
FF = Fork Fork
EE = Eye Eye
TE = Toggle Eye
TT = Toggle Toggle

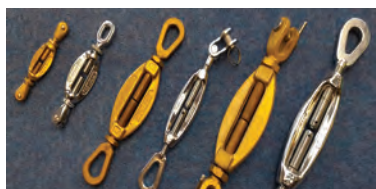



Lewmar Self Tailing Winches

Lewmars Ocean winch range is the most popular winch ever made. Its styling still attracts boat builders looking for a classic look, or boat owners looking to upgrade or replace their existing winches.

- Easy Servicing — no tools required
- Bronze finish also available - contact your retailer
- Convertible to electric from size 40 upwards
- Available in Size 16 to Size 65
- Solid construction respected by boat builders and sailors for generations

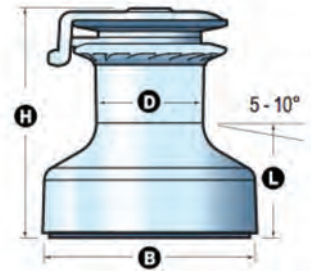

Part Number	Description	Gear Ratio		Power Ratio		WLL		WEIGHT		Drum Dia.	Base Dia.	Height	Entry Line	Line Size
		1st	2nd	1st	2nd	KG	LB	KGW	LB	MM	MM	MM	MM	MM
LEW/49008031	8B GREY INFILL ON BRONZE WINCH	2:1	-	-	-									
LEW/49016002	16BBST ALL BRONZE SELF TAILING WINCH	2:1	-	15.8:1	-	570	1257	3.9	8.6	65.7	121	145.5	58	8-12
LEW/49030002	30BBST ALL BRONZE SELF TAILING WINCH	2:1	4.2:1	13.8:1	29.2:1	685	1510	5.6	12.3	74	138	160.5	69	8-12
LEW/49046060	46BBST ALL BRONZE SELF TAILING WINCH	2.4:1	7.6:1	13.9:1	44.8:1	1200	2646	9.7	21.3	87	168	192	84	8-14
LEW/49048060	48BBST ALL BRONZE SELF TAILING WINCH	2.6:1	9:1	13.9:1	48.6:1	1250	2756	12.1	26.7	93	181	208	86	8-14
LEW/49050002	50BBST ALL BRONZE SELF TAILING WINCH	2.8:1	10.5:1	13.8:1	50.6:1	1250	2756	16.3	35.9	105	200	238	106	8-16
LEW/49054002	54BBST ALL BRONZE SELF TAILING WINCH	2.8:1	11.2:1	13.8:1	54.1:1	1480	3263	17	37.5	105	205	250	115	8-16
LEW/49058002	58BBST ALL BRONZE SELF TAILING WINCH	3.1:1	13.5:1	13.5:1	58.1:1	1600	3524	20.8	45.8	118	228	266	118.5	8-18
LEW/49065002	65BBST ALL BRONZE SELF TAILING WINCH	3.1:1	15.3:1	13.4:1	66:1	1700	3748	23.8	52.4	118	231	271	121.5	8-18
LEW/48040260	40BBST ALL BRONZE SELF TAILING DECK UNIT													8-14
LEW/48046260	46BBST ALL BRONZE SELF TAILING DECK UNIT													8-16
LEW/48048260	48BBST ALL BRONZE SELF TAILING DECK UNIT													8-16
LEW/48050202	50BBST ALL BRONZE SELF TAILING DECK UNIT													8-16
LEW/48054202	54BBST ALL BRONZE SELF TAILING DECK UNIT													8-18
LEW/48058202	58BBST ALL BRONZE SELF TAILING DECK UNIT													8-18
LEW/48065202	65BBST ALL BRONZE SELF TAILING DECK UNIT	3.1:1	15.3:1	13.4:1	66:1	1700	3748	23.8	52.4	118	231	271	121.5	8-18

Ocean Winch Electric Conversion Kit

Upgrade your manual winch to an electric model with the Ocean upgrade kit. The kit contains all you need to convert your existing manual winch to an electric powered version.

Kit includes



Power Drive



Motor Gearbox



Contactor



Circuit Breaker



Switch

PART NUMBER	DESCRIPTION
LEW48040300	40ST 12V 'E' Conversion Kit
LEW48046300	46ST 12V 'E' Conversion Kit
LEW48048300	48ST 12V 'E' Conversion Kit
LEW48050300	50ST 12V 'ELS' Conversion Kit
LEW48054300	54ST 12V 'ELS' Conversion Kit
LEW48058300	58ST 12V 'ELS' Conversion Kit

Mounting Instructions

Ocean 16ST	5 x M6 (1/4 in) c'sk head screws on 94mm (3 ¹¹ / ₁₆ in) PCD
Ocean 30ST	5 x M6 (1/4 in) c'sk head screws on 113mm (4 ¹⁵ / ₃₂ in) PCD
Ocean 40ST	5 x M6 (1/4 in) c'sk head screws on 121mm (4 ³ / ₄ in) PCD
Ocean 46ST	5 x M8 (5/16 in) c'sk head screws on 136mm (5 ¹¹ / ₃₂ in) PCD
Ocean 48ST	5 x M8 (5/16 in) c'sk head screws on 150mm (5 ²⁹ / ₃₂ in) PCD
Ocean 50-54ST	6 x M8 (5/16 in) c'sk head screws on 165mm (6 ¹ / ₂ in) PCD
Ocean 58-65ST	5 x M10 (3/8 in) c'sk head screws on 184mm (7 ¹ / ₄ in) PCD



LEWMAR®

LEWMAR®

Lewmar Winch Selection Guide

Efficient sail handling begins with the selection of the correct winch. To help you select from the winches described in the following pages the chart below is designed as a quick reference to match application, yacht size and winch. Cross reference your yacht size (for masthead rigs) or sail area (fractional rigs) with application, to ascertain the correct winch. You can also send your deck and sail plans to your Lewmar representative, they will be pleased to make

individual recommendations. REMEMBER runner winch and mainsheet winch selection depends on the purchase system fitted, and expected loads. Dynamic sail loads can easily increase the loads dramatically. Multihulls generally have a higher righting moment than monohulls of equivalent lengths, resulting in higher dynamic loading, therefore, winch size needs to be larger – consult your Lewmar representative or rigger for further guidance.

Sail Area

Application	m ft	BOAT LENGTH OVERALL																					
		6.1-7.6 20-25	7.6-8.8 25-29	8.8-10.1 29-33	10.1-10.7 33-35	10.7-11.3 35-37	11.3-11.9 37-39	11.9-12.5 39-41	12.8-14.6 42-48	14.6-16.8 48-55	16.8-18.9 55-62	18.9-21.6 62-71											
Genoa (ft²/m²)		200	19	300	28	350	33	470	44	550	51	600	56	750	70	900	84	1500	139	1900	177	2300	214
Spinnaker (ft²/m²)		300	28	400	37	600	56	800	74	1000	93	1200	111	1400	130	1600	149	3000	279	3800	353	4600	427
Main (ft²/m²)		120	11	150	14	180	17	210	20	230	21	260	24	300	28	350	33	750	70	875	81	1000	93

APPLICATION	SIZE	BOAT LENGTH OVERALL															
		m ft	6.1 20	7.6 25	8.8 29	10.1 33	10.7 35	11.3 37	11.9 39	12.5 41	14.6 48	16.8 55	18.9 62	21.6 71	24.4 80	25+ 80+	
Genoa Sheet	7																
	16																
	30																
	40																
	45																
	50																
	55																
	65																
Spinnaker Sheet	6																
	7																
	8																
	16																
	30																
	40																
	45																
	50																
Main Sheet	6																
	7																
	16																
	30																
	40																
	45																
	50																
	55																
Genoa Halyard	6																
	7																
	16																
	30																
	40																
	45																
	50																
	55																
Spinnaker Halyard	6																
	7																
	8																
	16																
	30																
	40																
	45																
	50																
Main Halyard	6																
	7																
	8																
	16																
	30																
	40																
	45																
	50																
Runners	45																
	50																
	55																
	65																
	70																

Lighter shading represents the upper limit of the model. If in doubt, move up a model.



Tufnol Type Composite Laminated Blocks

These traditional laminated plastic blocks are both strong in use and competitively priced. They incorporate a strong AISI 304 stainless steel frame and brass bush bearings, and all breaking loads have been certified by Germanischer Lloyd in Hamburg. (1 daN equals approximately 1 kilo).

Note, new 13mm size.

Single Block with Bow

Part No.	Rope Dia	Sheave Dia	Breaking Load daN	s.w.l. daN
4300/00/10	10mm	30mm	880	440
4300/00/12	12mm	35mm	1120	560
4300/00/13	13mm	43mm	1500	750
4300/00/14	14mm	50mm	2010	1005
4300/00/16	16mm	63mm	2210	1105



Single Block with Eye

Part No.	Rope Dia	Sheave Dia	Breaking Load daN	s.w.l. daN
4305/00/10	10mm	30mm	800	400
4305/00/12	12mm	35mm	1110	555
4305/00/13	13mm	43mm	1200	600
4305/00/14	14mm	50mm	2000	1000
4305/00/16	16mm	63mm	2190	1095



Single Block with Swivel

Part No.	Rope Dia	Sheave Dia	Breaking Load daN	s.w.l. daN
4310/00/10	10mm	30mm	810	405
4310/00/12	12mm	35mm	1110	555
4310/00/13	13mm	43mm	1200	600
4310/00/14	14mm	50mm	2050	1025
4310/00/16	16mm	63mm	2140	1070



Single Block with Swivel and Becket

Part No.	Rope Dia	Sheave Dia	Breaking Load daN	s.w.l. daN
4315/00/10	10mm	30mm	820	410
4315/00/12	12mm	35mm	1250	625
4315/00/13	13mm	43mm	1490	745
4315/00/14	14mm	50mm	2210	1105
4315/00/16	16mm	63mm	2800	1400



Single Block with Eye and Becket

Part No.	Rope Dia	Sheave Dia	Breaking Load daN	s.w.l. daN
4320/00/10	10mm	30mm	820	410
4320/00/12	12mm	35mm	1250	625
4320/00/13	13mm	43mm	1210	605
4320/00/14	14mm	50mm	2210	1105
4320/00/16	16mm	63mm	2800	1400



Single Block with Swivel and Becket

Part No.	Rope Dia	Sheave Dia	Breaking Load daN	s.w.l. daN
4325/00/10	10mm	30mm	830	415
4325/00/12	12mm	35mm	1350	675
4325/00/13	13mm	43mm	1210	605
4325/00/14	14mm	50mm	2020	1010
4325/00/16	16mm	63mm	2200	1100





Double Block with Bow

Part No.	Rope Dia	Sheave Dia	Breaking Load daN	s.w.l. daN
4330/00/10	10mm	30mm	600	300
4330/00/12	12mm	35mm	900	450
4330/00/13	13mm	43mm	900	450
4330/00/14	14mm	50mm	1720	860
4330/00/16	16mm	63mm	2000	1000



Double with Swivel

Part No.	Rope Dia	Sheave Dia	Breaking Load daN	s.w.l. daN
4335/00/10	10mm	30mm	630	315
4335/00/12	12mm	35mm	960	480
4335/00/13	13mm	43mm	990	495
4335/00/14	14mm	50mm	1740	870
4335/00/16	16mm	63mm	2030	1015



Double Block with Bow and Becket

Part No.	Rope Dia	Sheave Dia	Breaking Load daN	s.w.l. daN
4340/00/10	10mm	30mm	610	305
4340/00/12	12mm	35mm	910	455
4340/00/13	13mm	43mm	900	450
4340/00/14	14mm	50mm	1700	850
4340/00/16	16mm	63mm	2040	1020



Double Block with Swivel and Becket

Part No.	Rope Dia	Sheave Dia	Breaking Load daN	s.w.l. daN
4345/00/10	10mm	30mm	630	315
4345/00/12	12mm	35mm	970	485
4345/00/13	13mm	43mm	1000	500
4345/00/14	14mm	50mm	1710	855
4345/00/16	16mm	63mm	2010	1005
With Cam Cleat				
4370/00/16	16mm	63mm	2170	1085



Fiddle Blocks

Part No.	Rope Dia	Sheave Dia	Breaking Load daN	s.w.l. daN
With Bow				
4350/00/10	10mm	42mm & 20mm	760	380
4350/00/12	12mm	48mm & 25mm	1370	685
4350/00/13	13mm	59mm & 30mm	1340	670
With Eye				
4355/00/10	10mm	42mm & 20mm	710	355
4355/00/12	12mm	48mm & 25mm	1200	600
4355/00/13	13mm	59mm & 30mm	1210	605
With Swivel				
4360/00/10	10mm	42mm & 20mm	720	360
4360/00/12	12mm	48mm & 25mm	1200	600
4360/00/13	13mm	59mm & 30mm	1290	645
With Swivel, Becket and Cam Cleat				
4365/00/10	10mm	42mm & 20mm	740	370
4365/00/12	12mm	48mm & 25mm	1210	605
4365/00/13	13mm	59mm & 30mm	1200	600





Part No.
4300/SS/SUK/10 - Stand Up Kit for Size 10

Cheek Block



Part No.	Rope Dia	Sheave Dia	Breaking Load daN	s.w.l. daN
4395/00/10	10mm	30mm	600	300
4395/00/12	12mm	35mm	860	430
4395/00/13	13mm	43mm	810	405
4395/00/14	14mm	50mm	1500	750
4395/00/16	16mm	63mm	1810	905



Cam Cleat with Lead

Part No.	Rope Dia	Base Size
4455/00/10	8 - 10mm	80 x 45mm

Cam Cleat

Part No.	Rope Dia	Base Size
4450/00/10	8-10mm	76 x 35mm
4450/00/14	12-14mm	105 x 45mm



Single Wire Rope Block

Part No.	Wire Dia	Sheave Dia	Breaking Load daN	s.w.l. daN
4405/00/04	4mm	60mm	1130	565
4405/00/05	5mm	75mm	1200	600
4405/00/06	6mm	90mm	2040	1020
4405/00/08	8mm	100mm	2010	1005

Rope Sheave



Part No.	Rope Dia	Sheave Dia	Sheave Width	Bore
4470/00/25	10mm	25mm	11mm	6mm
4470/00/30	10mm	30mm	11mm	6mm
4470/00/35	10mm	35mm	11mm	6mm
4470/00/40	10mm	40mm	11mm	6mm
4470/00/50	12mm	50mm	13mm	8mm
4470/00/60	12mm	60mm	13mm	8mm
4470/00/70	14mm	70mm	16mm	10mm
4470/00/80	14mm	80mm	16mm	10mm
4470/00/90	16mm	90mm	18mm	10mm
4470/00/100	16mm	100mm	18mm	10mm

Wire Rope Sheave



Part No.	Wire Dia	Sheave Dia	Sheave Width	Bore
4475/00/25	4mm	25mm	9mm	6mm
4475/00/30	4mm	30mm	9mm	6mm
4475/00/35	4mm	35mm	9mm	6mm
4475/00/40	4mm	40mm	9mm	6mm
4475/00/50	5mm	50mm	11mm	8mm
4475/00/60	5mm	60mm	11mm	8mm
4475/00/70	6.5mm	70mm	13mm	10mm
4475/00/80	6.5mm	80mm	13mm	10mm
4475/00/90	8mm	90mm	15mm	10mm
4475/00/100	8mm	100mm	15mm	10mm

Large Tufnol Type Blocks

Manufactured to the same high standard as the smaller range, these extremely strong blocks are suitable for ropes sizes 13mm to 22mm. They are internally bound with stainless steel and come in four configurations to suit most applications. Approved by Germanischer Lloyd in Hamburg.



4410



4430

Single with Bow	SWL daN	Single with Swivel	SWL daN	Rope Diameter	Sheave Diameter
4410/OO/13	905	-	-	13mm	75mm
4410/OO/16	2075	4430/OO/16	1845	16mm	90mm
4410/OO/20	2260	4430/OO/20	2435	20mm	100mm
4410/OO/22	3155	4430/OO/22	3290	22mm	120mm



4415

Single with Bow & Becket	SWL daN	Single with Swivel & Becket	SWL daN	Rope Diameter	Sheave Diameter
4415/OO/13	980	-	-	13mm	75mm
4415/OO/16	2105	4435/OO/16	1850	16mm	90mm
4415/OO/20	2340	4435/OO/20	2415	20mm	100mm
4415/OO/22	3210	4435/OO/22	3290	22mm	120mm



4400

Double with Bow	SWL daN	Double with Swivel	SWL daN	Rope Diameter	Sheave Diameter
4420/OO/13	1100	-	-	13mm	75mm
4420/OO/16	2400	4440/OO/16	2105	16mm	90mm
4420/OO/20	2585	4440/OO/20	2555	20mm	100mm
4420/OO/22	3155	4440/OO/22	3300	22mm	120mm



4445

Double with Bow & Becket	SWL daN	Double with Swivel & Becket	SWL daN	Rope Diameter	Sheave Diameter
4425/OO/13	1005	-	-	13mm	75mm
4425/OO/16	2400	4445/OO/16	2105	16mm	90mm
4425/OO/20	2600	4445/OO/20	2555	20mm	100mm
4425/OO/22	3210	4445/OO/22	3265	22mm	120mm

Heavy Duty Stainless Steel Blocks

An extremely robust range of stainless steel blocks with brass bushed tufnol type sheaves. Designed for high loads and harsh conditions, these blocks come with swivel heads and becketts as standard and are available for both rope and wire rope. As used by the Danish Navy.

Blocks for Rope



Single	Load daN	Double	Breaking Load daN	Rope Diameter	Sheave Diameter
4800/SS/12	4210	4850/SS/12	4210	12mm	50mm
4800/SS/14	4210	4850/SS/14	4210	14mm	63mm
4800/SS/16	7160	4850/SS/16	7090	16mm	80mm
4800/SS/18	10750	4850/SS/18	10750	18mm	100mm

Blocks for Wire



Single	Load daN	Double	Breaking Load daN	Wire Diameter	Sheave Diameter
4805/SS/05	4210	4855/SS/05	4210	5mm	50mm
4805/SS/06	4210	4855/SS/06	4210	6mm	63mm
4805/SS/08	7160	4855/SS/08	7090	8mm	80mm
4805/SS/10	10750	4855/SS/10	10750	10mm	100mm

Classic Wooden blocks

Victory collection

Combining high performance engineering and classic design, our range of wooden blocks has been designed for mariners who appreciate elegance and want technical excellence. The range has been named in honour of the flagship of the British Navy – the HMS Victory.

Crafted by sailors for sailors, the Victory blocks are manufactured in the UK from traditional ash wood, with a high gloss marine varnish finish. Victory blocks are bolted together allowing for servicing or refinishing.

The Victory collection of wooden blocks not only look good, but are highly durable and designed to withstand many years of use in harsh marine environments. The sleek style wooden plates conceal the modern technical working of Barton's proven high performance engineering, with Delrin ball bearings, Torlon needle bearings, gun metal shaded sheave and solid brass fittings.

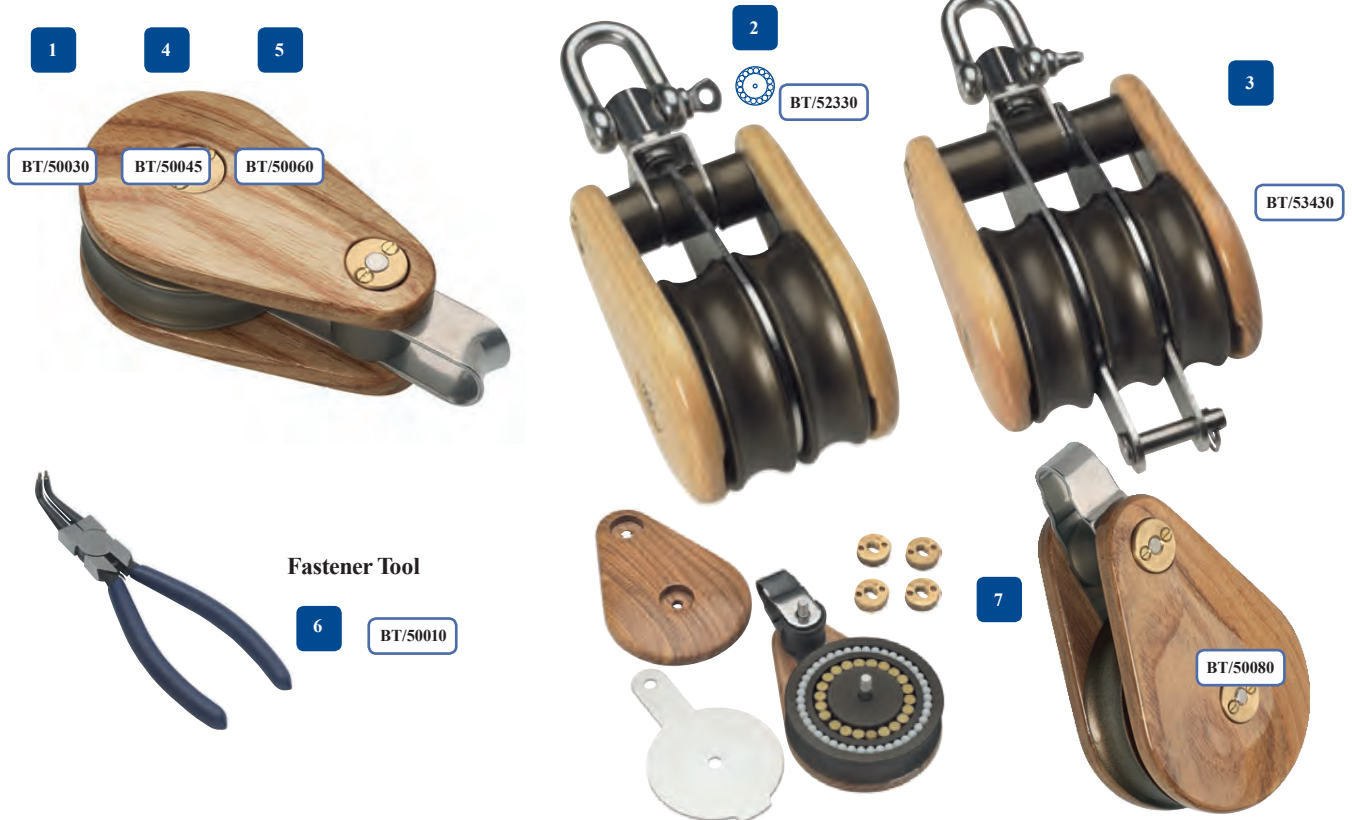

Number	Description:	Part number	Bearing	Length (mm)	Weight (g)	SWL (kg)	Break Load (kg)
1	Single-fixed eye	BT/50030	Delrin balls	70	46	350	700
	Single-fixed eye + becket	BT/50230	Delrin balls	90	54	350	700
	Single-swivel	BT/50330	Delrin balls	88	71	350	700
	Single-swivel + becket	BT/50430	Delrin balls	109	79	350	700
	Double-fixed eye	BT/52030	Delrin balls	70	67	350	700
2	Double-fixed eye +becket	BT/52230	Delrin balls	90	75	350	700
	Double-swivel	BT/52330	Delrin balls	88	92	350	700
	Double-swivel + becket	BT/52430	Delrin balls	109	100	350	700
	Triple-fixed eye	BT/53030	Delrin balls	70	90	350	700
	Triple-fixed eye + becket	BT/53230	Delrin balls	90	96	350	700
3	Triple-swivel	BT/53330	Delrin balls	88	115	350	700
	Triple-swivel + becket	BT/53430	Delrin balls	109	121	350	700
	Triple-swivel & Becket	BT/53445	Delrin balls	127	220	350	700
4	Single-fixed eye	BT/50045	Delrin balls	90	85	350	700
	Single-fixed eye + becket	BT/50245	Delrin balls	111	97	350	700
	Single-swivel	BT/50345	Delrin balls	105	107	350	700
	Single-swivel + becket	BT/50445	Delrin balls	127	119	350	700
	Double-fixed eye	BT/52045	Delrin balls	90	139	350	700
	Double-fixed eye + becket	BT/52245	Delrin balls	111	151	350	700
	Double-swivel	BT/52345	Delrin balls	105	159	350	700
	Double-swivel + becket	BT/52445	Delrin balls	127	171	350	700
	Triple-fixed eye	BT/53045	Delrin balls	90	189	350	700
	Triple-fixed eye + becket	BT/53245	Delrin balls	111	201	350	700
5	Triple-swivel	BT/53345	Delrin balls	105	208	350	700
	Triple-swivel & Becket	BT/53445	Delrin balls	127	220	350	700
5	Single-fixed eye	BT/50060	Delrin balls	120	190	700	1400
6	Fastener Tool	BT/50010	Delrin balls	-	-	-	-
7	Torlon Needle Bearing Interior	BT/50080	Delrin balls	-	-	-	-



Polished Brass Life Buoy Holder

This product is made of a thick brass plate bent to accommodate standard life buoys, but can also be used as a line tidy.

Internal Size 120mm Deep by 90mm wide

Overall Size 255mm long and 63mm wide with a projection of 100mm

8366/BR



Clinometers

This product is made in UK and are ideal for smaller vessels. The Chrome needle version is open and the white needle version is protected by a plastic clear screen.

BR/231 - Chrome Version

BR/343 - White needle with Cover

Fiddle Rail Parts

Made from brass and ideal for any type of cooker or shelving unit. Designed to work with 6mm or 1/4" brass bar. Overall Height 41mm Base Dia. 23mm



3125/06/01 - Centre Bracket

3125/06/02 - Corner Bracket

3125/06/03 End Stop Bracket

BAR/06/RND - 6mm Brass Bar per M

Stainless Jack Staff

Made from 316 stainless steel and designed for the forward end of vessels. It has a sealed M8 thread socket on the deck so even when removed the vessel remains water tight. 390mm OA 350 Shaft Length Base Plate Diameter 55mm Shaft Dia. 8mm

9500/SS - Polished Stainless



Outboard Bracket - Mounting Bracket

This product was originally designed for mounting outboards on the sterns of vessels, but has also been seen as mounts for tables, and seating. Made in gunmetal for maximum engine size 6HP. Tapered key way locking.

160mm X 160mm Projects 40mm with a brass knurled retaining bolt.

9998/GM - Gunmetal Finish



Folding Seat Bracket

This product is made in Gunmetal and is an original 1940's design. Seat Base supports 230mm x 260mm Wall Plate 220mm x 75mm Preturdes 85mm. Could be used for a small table as well.

2526/GM





Hot Pot Stove



Hot Pot Stove

A slimline solid fuel cabin heater designed for boats up to around 30 feet (10 metres). Solidly made in the UK from cast iron and finished black with either brass or chrome fitments. It is supplied complete with two internal grids, ash pan and handle. Can be easily installed using the wide range of stainless steel fittings on this page. Weight 16kgs.

Key Features

- Cast iron construction for good heat radiation.
- Infinite air intake control to adjust heat.
- Positive front door lock for security.
- Slim body with small footprint.
- Will burn most solid fuels (not charcoal).
- Stainless steel installation fittings available.
- Safe and secure.

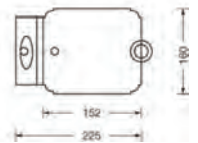
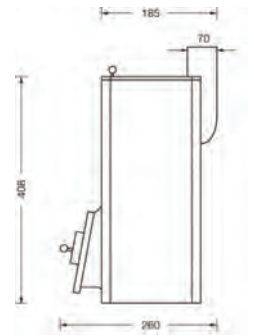

3126/BR Stove with brass fitments

3126/CP Stove with chrome fitments

Stainless Steel Flue System

This range of acid resistant stainless steel pipes and fittings are ideal for installing the Hot Pot stove. All parts push fit together and are compatible for a 70mm installation.



Flue Pipe

Available in four lengths

- 3130/SS/0200 Length 200mm
- 3130/SS/0330 Length 330mm
- 3130/SS/0500 Length 500mm
- 3130/SS/1000 Length 1 metre



Elbow

Available in two angles.

	3131/SS/45	3131/SS/90
Angle	45°	90°
Length mm's	165 + 165	185 + 185



Deck Flange

Available straight or with a choice of three angles to suit the deck camber. All deck flanges have a 160mm over-all diameter.

- 3132/SS Straight
- 3132/SS/03 Angle 3°
- 3132/SS/06 Angle 6°
- 3132/SS/09 Angle 9°



Flue Hood

Compact round shape which is rain proof whilst producing a good draft. Fits securely on to the deck flange.

- Height: 240mm (9½")
- Top Diameter: 130mm (5")
- 3133/SS



Flue Guard

Stainless steel guard to minimise the risk of contact burns but still allowing heat to radiate from the flue. Also available in brass or copper.

- 3134/SS/0500 Length 500mm
- 3134/SS/1000 Length 1 metre



Flue Cap

To cap flue when hood is removed. 3135/SS



Plunger Galley Pump

A practical and stylish double action galley pump with swivelling faucet and brass knob. High quality build and with service kits available for long life and optimum performance. Suitable for fresh or salt water. Barrel diameter 1" (25mm) with connection for pipe 1/2" - 5/8" (13-16mm). Available polished brass or chrome plated.

Brass	Chrome	Strokes per Litre	Above Counter	Below Counter
2593/BR	2593/CP	13	5" 127mm	9 1/2" 241mm

Service Kit: 2593/SK



Lever Galley Pump

High quality traditional design lever pump in polished brass or chrome plated. Large 1 5/8" (41mm) barrel with connection for 1/2" - 3/4" (13-19mm) pipe. For fresh or salt water.

Brass	Chrome	Strokes per Litre	Above Counter	Below Counter
2596/BR	2596/CP	12	8 1/2" 216mm	3" 76mm

Service Kit: 2596/SK



Swivelling Faucet

High quality all brass construction for use with hand or foot pump. Pipe connection 1/2" - 5/8" (13-16mm).

Available polished brass or chrome plated.

Brass	Chrome	Above Counter	Below Counter
2599/BR	2599/CP	4 1/4" 120mm	2" 50mm

Service Kit: 2599/SK



Step Light (Rebated)

Recessed step or bulkhead light with heavy ribbed glass and polished cast brass guard. Also available in chrome. Fitted SBC bulb holder which can accept our 60 lm LED 6001/12/60. Projection only 1" (25mm).

Brass	Chrome	Height	Width	Projection
7576/BR	7576/CP	5 1/2" 140mm	4 3/8" 111mm	1 1/2" 38mm



Step Light (Surface Mount)

Recessed step or bulkhead light with heavy ribbed glass and polished cast brass guard. Also available in chrome. Fitted SBC bulb holder which can accept our 60 lm LED 6001/12/60. Projection only 1" (25mm).

Brass	Chrome	Switched	Height	Width	Projection
7276/BR/SW	7276/CP/SW	Yes	150mm	90mm	30mm
7276/BR	7276/CP	No	150mm	90mm	30mm





Lighting

Please note that all lights have either warm white LED's fitted or recommended LED's to be ordered separately. All LED's operate from 10 to 30 volts DC, except Eyelid Light. See light descriptions and page 48 for full LED listings.

NEW

Oval Eyelid Light



This classically styled, surface mounted, light is manufactured in polished brass and fitted with a frosted lens. Supplied with a 70 lumen LED strip as standard, additional length can be ordered to double the light output. Available in 12v and 24v, these are ideal for berth, step or walkway lighting wherever unobtrusive lighting is required.

	Brass	Chrome	Dimensions	Projection
12v	7605/BR/12	7605/CP/12	5 3/4" x 3 3/8" 148mm x 100mm	1 1/2"
24v	7605/BR/24	7605/CP/24		40mm
LED Strip	7605/LED/12	7605/LED/24	50mm long x 15mm wide	

Recessed Square Berth Light - with switch



Polished cast brass and fitted with a frosted glass and switch. This recessed pattern requires a depth of 1" (25mm). Fitted with 2 warm white 60 lumen LED's as standard.

Brass	Chrome	Front	Rear Case	Projection
7614/BR	7614/CP	5 1/2" x 5" 140 x 125mm	5 1/4" x 4 3/8" x 1" 134 x 105 x 25mm	1 1/2" 38mm

Recessed Square Berth Light - without switch

NEW



For remote switching, especially when 2 or more lights are fitted in a cabin, this popular light is now available without switch. Polished brass front with frosted glass. Fitted with 2 warm white 60 lumen LED's as standard.

Brass	Chrome	Front	Rear Case	Projection
7615/BR	7615/CP	5 1/2" x 5" 140 x 125mm	5 1/4" x 4 3/8" x 1" 134 x 105 x 25mm	1 1/2" 38mm

Teardrop Berth Light



Polished cast brass and fitted with a frosted dome glass and switch, this unique light is fitted with a warm white 60 lumen LED's as standard.

Brass	Chrome	Height	Width	Projection
7246/BR	7246/CP	5 3/4" 145mm	3" 75mm	2" 50mm

Brass Bracket Light (without switch)



This graceful light is cast in brass with a polished finish and supplied with a frosted bell glass and SBC (BA15d) bulb holder. Will accept our 60 lumen warm white LED 6001/12/60 see page 48.

Height with glass 4.1/4" (108mm). Projection 3.1/2" (89mm)

Part No. 7215/BR Brass Part No. 7215/CP Chrome

Brass Bracket Light (with switch)



A switched version of the light above. Polished cast brass and supplied with a frosted bell glass, SBC (BA15d) bulb holder and toggle switch. Will accept our 60 lumen warm white LED 6001/12/60 see page 48.

Height with glass 5" (125mm). Projection 5" (125mm).

Part No. 0396/BR Brass Part No. 0396/CP Chrome



Deck Head Lights - 'Jelly Mould'

These high quality period lights are now available in a variety of versions that can be mixed throughout the boat for maximum practicality and uniformity. Utilising the same genuine frosted glass, the heavy cast brass housing can be supplied with or without switch and in a choice of finishes. Suitable for many kinds of traditional craft.

- With or without switch
- Polished brass, chrome or nickel plate
- Full back case or low profile
- Fitted LED's 12v - 30v as standard
- Red/White option for night vision



Deep cast brass base for surface mounting. Available with switch on the side or without switch. Fitted warm white LED 165 lm.



	Brass	Chrome	Overall Diameter	Projection
Without switch	0391/BR	0391/CP	6 ³ / ₄ " 170mm	2 ¹ / ₄ " 58mm
With switch	0392/BR	0391/CP		

Night Vision (with switch)

This light is the same construction as the switched 0392 above, but comes fitted with a red/white LED. When first switched on it always displays the red light first to preserve your night vision. If white light is required, simply turn off and on again and the white light will come on. No special wiring is required.



Brass	Chrome	Overall Diameter	Projection
0392/BR/RW	0392/CP/RW	6 ³ / ₄ " 170mm	2 ¹ / ₄ " 58mm

Low Profile (without switch)

This low profile version is ideal for when headroom is restricted as it has a projection of only 1¹/₂" (40mm), which is ³/₄" (18mm) less than the standard light. To achieve this a flat stainless steel base is utilised which is concealed by the same brass bezel and glass as above.

Fitted warm white 165 lm. No switch.



Brass	Chrome	Overall Diameter	Projection
0393/BR	0393/CP	6 ³ / ₄ " 170mm	1 ¹ / ₂ " 40mm

Art Deco Interior Lights

Three styles of attractive period lights with genuine moonstone glass. The 0331 has a Stainless back plate and the 7502 & 0333 has a front silver trim. Both are fitted with 2 warm white LED's to give a pleasing even light. (0331 has 1 LED)

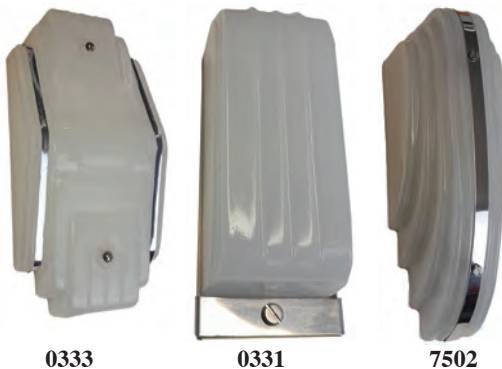

0333

0331

7502

Part No.	Length	Width	Projection
0333	250mm	110mm	65mm
0331	160mm	65mm	65mm
7502	215mm	73mm	66mm



Lighting

Weatherproof Bulkhead Light Without Guard

A new version of our bulkhead light for when a guard is not required, ideal for saloon or bathroom lighting. Available polished brass with clear glass or chromed with frosted glass. SBC lamp holder.

NEW

Suggested LED 6001/12/60 60 lm.



Part No.	O.A. Length	Projection	Bulb Holder
7208/BR/CL	6½" 165mm	3½" 85mm	SBC
7208/CP/FR			



Weatherproof Guarded Light (bulkhead fitting)

Similar to the above, this light is of all brass construction with a 90 degree bracket for fixing to a bulkhead. Suggested LED 6001/12/60 60 lm.

Part No.	O.A. Length	Projection	Bulb Holder
7207/BR/M/CL	6½" 165mm	3½" 85mm	SBC



Weatherproof Guarded Light

This traditional light is of all brass construction with a polished finish. The strong guard screws onto a seal in the base and protects the clear glass. Suggested LED 6001/12/60 60 lm.

Part No.	Length	Flange Diameter	Bulb Holder
7203/BR/M/CL	4⅞" 105mm	3⅞" 80mm	SBC



Weatherproof Guarded Bulkhead Light

Cast in brass with traditionally wired hinged door secured with three brass swing bolts with wing nuts on to a rubber seal. Polished outer surface and fitted with clear glass, SBC bulb holder and brass cable gland. This is a deluxe, hand made light of unique character. Suggested LED 6001/12/60.

Brass	Body Diameter	O.A. Diameter	Projection
7425/BR	4½" 114mm	6" 150mm	2½" 64mm

Bulkhead Light - Powder Coated

Cast in aluminium or gunmetal and fitted with an SBC bulb holder, cable gland and front seal. Powder coated either white with clear glass and brass gland or matt black with frosted glass and chrome gland. Suggested LED 6001/12/60.



With Clear Glass	With Frosted Glass	Body Diameter	O A Diameter	Projection
7425/AL/WH Aluminium White	7425/AL/BK Aluminium Black	4½" 114mm	5½" 140mm	2½" 65mm
7425/GM/CL Gunmetal	7425/GM/FR Gunmetal	4½" 114mm	5½" 140mm	2½" 65mm



Mast Light - New Style

NEW

A new development of this classic light now means that it can be wired directly to 110/220v AC. Ideal for larger vessels where mains voltage is often installed or for smaller boats linked to shore power. Also suitable for pontoons and shore side lighting, avoiding the need to fit a transformer.

12v/24v DC supply versions available as before.

Cast in bronze with a choice of finishes or in anodised aluminium. The base of the light is angled up 10 degrees to aid the throw of light and a hinged glazed door with a seal is fitted. Back gasket also included. Rated IPX5



Mast Light - 110/220v AC

Available rear wired only with a GU10 lamp holder included, which offers the opportunity of selecting from a wide range of LED's in terms of angle and strength of light. This makes it possible to fit the correct LED taking into account the height the light is mounted from the surface to be lit and the spread and light brightness required.



Part No	Material	Height	Width	Projection
0760/AL/AN	Anodised Aluminium	5¼" 135mm	3" 75mm	¾" 81mm
0760/GM/PO	Polished Gunmetal	5¼" 135mm	3" 75mm	¾" 81mm
0760/GM/SD	Sandblasted Gunmetal	5¼" 135mm	3" 75mm	¾" 81mm
0760/GM/WE	Weather/Aged Gunmetal	5¼" 135mm	3" 75mm	¾" 81mm
0760/CP	Chrome Plated Gunmetal	5¼" 135mm	3" 75mm	¾" 75mm

Mast Light - 12v/24v DC

Available for wiring through a top water tight gland or through the back, this light is supplied with a G4 lamp holder for low voltage LED's of varying degrees of spread and brightness.



Rear Wired	Top Wire Entry	Material	Height	Width	Projection
0761/AL/AN	0761/AL/AN/TOP	Anodised Aluminium	5¼" 135mm	3" 75mm	¾" 81mm
0761/GM/PO	0761/GM/PO/TOP	Polished Gunmetal	5¼" 135mm	3" 75mm	¾" 81mm
0761/GM/SD	0761/GM/SD/TOP	Sandblasted Gunmetal	5¼" 135mm	3" 75mm	¾" 81mm
0761/GM/WE	0761/GM/WE/TOP	Weather/Aged Gunmetal	5¼" 135mm	3" 75mm	¾" 81mm
0761CP	0761CP/TOP	Chrome Plated Gunmetal	5¼" 135mm	3" 75mm	¾" 81mm

Mast Light Backing Plate

Available in Polished, Sand Blasted and Aged Gunmetal or Anodised Aluminium, or Chrome Plated these backing plates can give the mast lights a little more presence and size once mounted to a wall.



Part No.	Finish	Size
0765/AL/AN	Anodised Aluminium	150mm x110mm
0765/GM/PO	Polished Gunmetal	150mm x110mm
0765/GM/SD	Sandblasted Gunmetal	150mm x110mm
0765/GM/WE	Weathered/Aged Gunmetal	150mm x110mm
0765/CP	Chrome Plated Gunmetal	150mm x110mm



Lighting

Navigation Lights - Oil



- 0151/BR/100/PO Port Light 4" Brass Oil
- 0151/BR/100/ST Starboard Light Port 4" Brass Oil
- 0152/BR/100 Masthead Light 4" Brass Oil
- 0152/BR/150 Masthead Light 6" Brass Oil
- 0157/BR/100 Stern Light 4" Brass Oil
- 0158/BR/100 Anchor Light 4" Brass Oil
- 0158/BR/150 Anchor Light 6" Brass Oil
- 0159/BR/100 Bi Colour Light 4" Brass Oil



- 0151/CO/100/PO Port Light 4" Copper Oil
- 0151/CO/100/ST Starboard Light Port 4" Copper Oil
- 0152/CO/100 Masthead Light 4" Copper Oil
- 0152/CO/150 Masthead Light 6" Copper Oil
- 0157/CO/100 Stern Light 4" Copper Oil
- 0158/CO/100 Anchor Light 4" Copper Oil
- 0158/CO/150 Anchor Light 6" Copper Oil
- 0159/CO/100 Bi Colour Light 4" Copper Oil

Internal Lights - Oil



DHR/8878/O

Galley Berth lamp brass/oil 335mm High



DHR/8209/O

Cabin Lamp oil 550mm High



DHR/8201L/O

Trawler Lamp C/W burner Brass/Oil
450mm High



DHR/8211/O

Trawler Lamp Junior C/W burner Brass/Oil
320mm High



DHR/8840/O

Berth lamp brass/oil 300mm High



4½" 114mm

DHR/8205/O

Sailors Lamp Brass Oil 580mm High



DHR/8807/O

Wall lamp, brass/oil 270mm High

Brass & Chrome Water Tight Gland

Manufactured from brass, and then Chromed (if required) these glands are ideal for a water tight joint up to a thickness of 10mm. Designed to work with and 8mm round cable

Part No. P/0761/BR/GLAND in Brass

Part No. P/0761/CP/GLAND in Chrome





Brass Gimbal Lamp

Manufactured from brass, which is then polished and lacquered and fitted with a burner with 1" wide wick. The weighted font holds 350ml of fuel and will keep the lamp burning for approximately 24 hours. Complete with smoke shade and arm. Overall Height: 9½" (240mm). Projection: 6¼" (160mm).

Part No. 0308/BR



Globe Lamp

Constructed of solid brass in traditional style. The glass globe is 7" (175mm) in diameter and the round burner gives an even bright light. The oil reservoir holds 250ml and will burn for approximately 35 hours.

Part No. 0191/BR



The 201 - LED Lighting Range

Constructed of solid brass spun casings made in traditional way here in the UK and fitted with Sealed LED units. This range of lights will operate on 12v -30v dc. IP67 Rated. Hand polished and then assembled these are a cost effective hand crafted light solution. Available in Chrome to order.



Part No. 2011/BR
Brass Spreader Light

140mm x 120mm



Part No. 2012/BR
Brass Mast Light

120mm Lens Bracket 290mm



Part No. 2013/BR
Brass Search Light

120mm Lens by 150mm High

S64 Standard for vessels up to 50m



Type (Item-No.)	4 ei	ht 56	Ener y consumption 54 6	7(isi) ility 5nm6	Diameter 89 ei ht 5mm6	7olta e 57 D&6
Port :%00.01)		330	0,8	'	64 / 54	12 / 24
Starboard :%01.02)		330	0,7	'	64 / 54	12 / 24
Stern :%02.00)		330	06"	'	64 / 54	12 / 24
Stern Suez red :%02.01)		330	2,1	3	64 / 65	12 / 24
Stern Kiel canal green (102.02)		330	%6"	3	64 / 65	12 / 24
Towing yellow :102.03)		330	0,7	'	64 / 54	12 / 24
Masthead / nm :%03.00)*		310	1,8	3	64 / 54	12 / 24
Masthead * nm :%04.00)		310	5	5	64 / 54	24
1ll-round, white :%05.00)		300	1	'	64 / 54	12 / 24
1ll-round, red :%05.01)		300	1,1	'	64 / 54	12 / 24
1ll-round, green :%05.02)		300	1	'	64 / 54	12 / 24
1ll-round, yellow :%05.03)		300	1	'	64 / 54	12 / 24
Signal light, white, 180° :%05.00-180)		370	0,9	'	64 / 54	12 / 24
Signal light, red, 180° :%05.00-180)		370	1	'	64 / 54	12 / 24
Signal light, green, 180° :%05.00-180)		370	0,9	'	64 / 54	12 / 24
Signal light, yellow, 180° :%05.03-180)		370	0,9	'	64 / 54	12 / 24
Bicolor (106.08)*		330	1,2	2	64 / 54	12 / 24
Tricolor :%07.08)*		330	1,6	2	64 / 54	12 / 24
Tricolor / Anchor (108.08) *		330	1,6/1,2	2	64 / 54	12 / 24

*for vessel up to 20 m

S64 Classic for vessels over 50m



S64 Bronze for vessels over 50m



More light, less energy consumption

The small things make the difference

The LED-Navigation lights Series S64 from K2W Lights are leading the market in both rivers and oceans. With its small size and its extremely low energy consumption, the product is adequate not only for professional vessels but also for small boats and yachts with smaller battery capacity. Due to high performance LED, all our navigation lights develop nautical reach of over two or three nautical miles, while the masthead light can reach even five or six nautical miles.



Our navigation lights S64 have been tested, approved and certified by DNV Germanischer Lloyd (DNV GL) according to the EU regulations. It corresponds in range, beam angle and colors to the international requirements of the COLREG 1972.



0098

The Series S64 belongs to the most efficient navigation lights of the market, and also the most robust and durable. Here the clients can choose between the two versions "Standard" and "Base", and also the two materials hard anodized aluminium or bronze. If you did not find a navigation lamp that suits your application, do not hesitate to contact us, we also deliver unique designs.

- Standard** - Seawater resistant aluminium with hard anodized coating;
- Classic** - Body in bronze, a beautiful design made of noble materials;
- Base** - For direct installation over horizontal surfaces;
- Base Bronze** - The classic version of the base lamp.

Double lanterns are available for vessels over 50m.

	K2W/960/00/SS - Stainless Steel Mount Bow or Stern K2W/960/00/BR—Brass Mount Bow or Stern
	K2W/960/01/SS - Stainless Steel Mount Starboard K2W/960/01/BR—Brass Mount Starboard
	K2W/960/02/SS - Stainless Steel Mount Port K2W/960/02/BR—Brass Mount Port
	K2W/960/03/SS - Stainless Steel Mount Mast Light K2W/960/03/BR—Brass Mount Mast Light
	K2W/960/04/SS - Stainless Steel Top Mount



Lighting



Brass Navigation Lights

This range of cast brass navigation lights are approved by the Italian RINA for boats up to 12 metres. They are supplied complete with 12v 18w bulbs and are available brass or chrome finish.

Brass	Chrome Plated	Type	Height	Width	Projection
0111/BR/P	0111/CP/P	Port	3½" 90mm	2¼" 70mm	2⅜" 62mm
0111/BR/S	0111/CP/S	Starboard			
0112/BR	0112/CP	Masthead			
0113/BR	0113/CP	Stern			

Brass Navigation Lights

This range of navigation lights is approved up to 20m. With Brass spinning tops and bases, given a traditional look and feel but comply with insurance and IRPCS. Bulbs are not included so they can be bought to suit owners voltages. Brushed stainless plates are fitted to control the arc of light.



Robust design



Waterproof IP56



MED 2014/90/EU
Wheelmark



Maintenance
friendly



Bulb Bay15d



12/24 VDC 25W

1114/BR/PRT	BRASS Port light, side mounting
1114/BR/STB	BRASS Starboard light, side mounting
1114/BR/STN	BRASS Stern light, side mounting
1114/BR/STM	BRASS Masthead/Steam light, side mounting
1114/BR/BI	BRASS Bi-color nav.light, base mounting
1114/BR/TRI	BRASS Tricolour light, base mounting
1114/BR/ANC	BRASS All-round white, base mounting
1114/CP/PRT	CHROME PLATED Port light, side mounting
1114/CP/STB	CHROME PLATED Starboard light, side mounting
1114/CP/STN	CHROME PLATED Stern light, side mounting
1114/CP/STM	CHROME PLATED Masthead/Steam light, side mounting
1114/CP/BI	CHROME PLATED Bi-color nav.light, base mounting
1114/CP/TRI	CHROME PLATED Tricolour light, base mounting
1114/CP/ANC	CHROME PLATED All-round white, base mounting



IMO APPROVED
BRASS/CHROME CAPPED
NAVIGATION LIGHTS
SUITABLE FOR VESSELS
UP TO 20m 2-3 N.M. Visibility



Navigation Lights

This range of navigation lights is approved up to 20m. These comply with insurance and IRPCS. Bulbs are not included so they can be bought to suit owners voltages. Black ABS plastic with brushed stainless plates to control the arc of light.

Part No	Description
DHR/HW35Z	DHR35 Stern Light Black Side Mount
DHR/HW35V	DHR35 Stern Light Black Base Mount
DHR/DKL35V	DHR35 Tri-colour Light Black Base Mount
DHR/BB35Z	DHR35 Port Light Black Side Mount
DHR/SB35Z	DHR35Starboard Light Black Side Mount
DHR/TKL35Z	DHR35 Bi Colour Light Black Side Mount
DHR/TKL35V	DHR35 Bi Colour Light Black Base Mount
DHR/TW35Z	DHR35 Mast/Steaming light Black Side Mount
DHR/RW35V	DHR All round/Anchor Light Black Base Mount

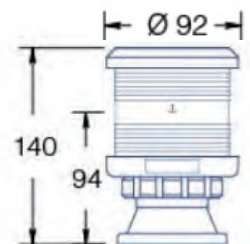

THE FULL RANGE OF DHR LIGHTS IS AVAILABLE
OTHER VARIATIONS HELD IN STOCK
PLEASE CONTACT SALES FOR FURTHER HELP

Lighting



Miniature Navigation Lights

Cast in gunmetal with a polished finish and also available chrome plated. These electric navigation lights have a plain lens and SBC bulb holder. Available in masthead and stern.



Gunmetal	Chrome	Type	Dimensions	
			O.A. Height x Diameter	
9733/GM	9733/CP	Masthead	5¼" x 3"	133 x 75mm
9734/GM	9734/CP	Stern		

Switch Panels

Made in solid polished brass or chrome with single pole switches.



Part Number Brass	Part Number Chrome Plate	Size	No. Switches
0261/BR/1	0261/CP/1	41mm x 40mm	1
0261/BR/2	0261/CP/2	41mm x 80mm	2
0261/BR/3	0261/CP/3	41mm x 120mm	3
0261/BR/4	0261/CP/4	41mm x 160mm	4

Part Number Brass	Part Number Chrome Plate	Size	No. Switches
0262/BR/1	0262/CP/1	60mm x 40mm	1
0262/BR/2	0262/CP/2	60mm x 80mm	2
0262/BR/3	0262/CP/3	60mm x 120mm	3
0262/BR/4	0262/CP/4	60mm x 160mm	4

Switches

Flush switch rated at 2 amps. Brass - same as in Davey Switch Panels.



Brass	Chrome	Type
0363/BR	0363/CP	Double Pole Switch
0362/BR	0362/CP	Single Pole Switch

Spare Glasses

We can supply spare glasses for many of the lights we sell. Please select from the table below by lamp number.



Part Number	To suit light
0041/CL	7203/BR/M & 7207/BR/M
0044/FR	7246 teardrop berth light
0234/GL	0234 hurricane lamp
0308/GL	0308/BR gimbal lamp
0390/GL/FR	0391, 0392 & 0393 jelly mould lights
0445	0396 & 7215 bracket lights
0760/OO/GL/CL	0760 mast lights
7425/GL/CL	7425 bulkhead lights (brass & aluminium)
7614/GL/FR	7614 recessed berth light

Lamp Wick Supplied by the metre.



Part Number	Width
0096/00/06	¼" 6mm
0096/00/10	⅜" 10mm
0096/00/12	½" 12mm
0096/00/16	⅝" 16mm
0096/00/19	¾" 19mm
0096/00/25	1" 25mm
0096/00/27	1⅝" 27mm
0096/00/32	1¼" 32mm



Lighting

Replacement LED's

All LED's listed here are warm white to preserve as much as possible the integrity of our traditional lights. They all work on a voltage range from 10 volts to 30 volts and offer a significant power saving over standard filament and halogen bulbs and are often interchangeable with them. Other variations are available on request.



Part No.	Cap Type	LED's	Lumens	Power Draw Watts	Body Dims mm's
6000/12/60	G4	12	60	0.6	20 long 8.2 dia.

As fitted to our lights 7246, 7614, 0330 and 7502



Part No.	Cap Type	LED's	Lumens	Power Draw Watts	Body Dims mm's
6000/18/210	G4	18	210	1.8	23 long 20 dia.

As fitted to our lights 0330 and 7502



Part No.	Cap Type	LED's	Lumens	Power Draw Watts	Dims mm's
6001/12/60	SBC	12	60	0.6	48 LOA 25 glass dia.

Suitable for our lights 0396, 7215, 7203, 7207, 7425 and 7576.
They will also suit any lamp with an SBC bulb holder.



Part No.	Cap Type	LED's	Lumens	Power Draw Watts	Dims mm's
6001/15/105	SBC	15	105	1.4	42 LOA 15 cap dia.

A brighter alternative to the one above. Will fit any SBC bulb holder.



Part No.	Cap Type	LED's	Lumens	Power Draw Watts	Dims mm's
6002/10/165	G4	10	165	2.2	40 dia.

As fitted to our lights 0391, 0392, and 0393.
The pins are 90 degrees from the centre back.



Part No.	Cap Type	LED's	Lumens	Power Draw Watts	Dims mm's
6002/15/190/RW	G4	12 white 3 red	190	2.4	44 dia.

A special unit which always lights red when first switched on but when turned off and on again will light warm white. Ideal for preserving night vision.
The pins are 90 degrees from the centre back.



Part No.	Cap Type	LED's	Lumens	Power Draw Watts	Dims mm's
6005/18/560	G4	18	560	7.0	49 dia.

Suitable for our 0761 mast light as a low wattage alternative to halogen.



Electric Horn

This horn is of all brass construction with a spun body and trumpet complemented with brass fastenings and bracket. Available in polished finish or chrome plated. 12v or 24v.

	12 Volt	24 Volt	Diameter	Length
Brass	2010/BR/12	2010/BR/24	4 3/8" 117mm	6" 150mm
Chrome	2010/CP/12	2010/CP/24		
Chrome with Red Int.	2010/CP/12/RED	2010/CP/24/RED		



Stormglass

Dating from 1750, this unusual and interesting instrument can indicate weather changes up to two days in advance. A version of this device was used on the 'Beagle' with Darwin in 1831.

Supplied complete with mount.

Height: 140mm

5504/BR Brass

5504/SS Polished Stainless Steel



Galileiglass

A novel way to check the temperature at a glance. Tags hanging from the balls show the relevant temperature.

Supplied complete with mount.

Height: 140mm

5507/BR Brass

5507/SS Polished Stainless Steel



Inglefield Pattern Flag Clips

Available in light and Admiralty pattern. Stamped brass.

Part No.	Type	Length
3430/BR/AP	Admiralty Pattern	3 1/2" 90mm
3430/BR/LP	Light Pattern	2 1/2" 65mm



Sounding Leads

Lead casting with brass thimble and hollow base for tallow. 4lb size also available in polished bronze.

Lead	Weight
3070/00/02	2lb 0.9kg
3070/00/04	4lb 1.8kg
3070/00/07	7lb 3.1kg
3070/00/14	14lb 6.2kg
Bronze	
3070/GM/04	4lb 0.9kg

Tallow



Part No.	Weight
2810/00/02	8oz 250grms
2810/00/05	11lbs 5kg



Door, Hatch & Interior Fittings

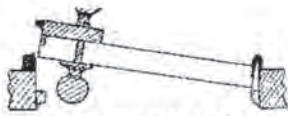

LEFT HAND LOCK
Normal door opening
inwards.



RIGHT HAND LOCK
Normal door opening
inwards.

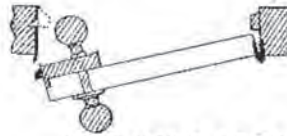

LEFT HAND LOCK
With reversed bolt for
door opening outwards.

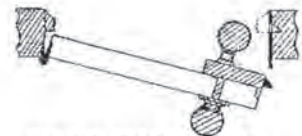

RIGHT HAND LOCK
With reversed bolt for
door opening outwards.

Sea Blue Security Locks

Sea Blue Security locks have been developed in the lock capital of England to withstand both corrosion and physical attack. Heavy steel full casings are used for strength with drab olive high chromate electro protection, as used on military equipment and vehicles where exposure to corrosion is a high factor. The whole case is then powder coated and packed with life long heavy grease that will not thin or dry out. Each set is built with high quality brass shoots, followers and forend plates to complement our range of furniture. Stainless steel forend and striker plates also available.

10 Year Guarantee



Mortice Lock - 5 lever

High level security lock with 5 internal levers. The latchbolt is reversible to suit left or right opening doors with a follower to suit furniture with standard 8mm square spindles. The deadbolt has two hardened steel rollers.

Supplied with striker plate and two keys.

Forend Plate	6" x 3/4"	152 x 20mm
Lock Case	4 1/4" x 2 1/2" x 1/2"	108 x 63 x 15mm
3500/BR	Brass forend	
3500/SS	Stainless Steel forend	



Toilet Lock

Utilising the same high quality case as above, this toilet door lock operates using furniture with 8mm spindles and toilet door turn & release furniture with 5mm spindles, as shown on page 51, to lock. The latchbolt is reversible to suit left or right opening doors.

Supplied with striker plate.

Forend Plate	6" x 3/4"	152 x 20mm
Lock Case	4 1/4" x 2 1/2" x 1/2"	108 x 63 x 15mm
3501/BR	Brass forend	
3501/SS	Stainless Steel forend	

Mortice Latch

For operation using furniture with 8mm spindles, this reliable latch is perfect for internal doors that do not need locking.

Supplied with striker plate.



Forend Plate	4" x 3/4"	102 x 20mm
Lock Case	2 3/8" x 2 1/2" x 1/2"	61 x 63 x 15mm
3502/BR	Brass forend	
3502/SS	Stainless Steel forend	



Flush Door Handles

Manufactured in Polish Brass and compatible with locks above. Sold separately. 16mm Deep.

3514/BR/70 Handle and Lock
70mm (w) x 146mm (h)

3513/BR/70 Handle Only
70mm (w) x 105mm (h)

Door, Hatch & Interior Fittings



Rim Locks

Traditional cast brass construction with polished cases and keepers. They have a two lever action with bronze springs and the latchbolt is reversible on the larger size.



Left Hand	Right Hand	Height		Width	
3522/BR/062/LH	3522/BR/062/RH	5"	125mm	2½"	62mm
3523/BR/125/LH	3523/BR/125/RH	4¾"	111mm	5"	125mm

Traditional Furniture

This range is supplied as knob & knob or ring and knob for both rim and mortice locks. The knob is 1¾" (44mm) in diameter and the ring is 2" (50mm). All sets come complete with round roses, escutcheons with covers and 5/16" (8mm) spindles.



Brass	Furniture Type	lock Type
9200/BR/K	Knob & Knob	Mortice
9200/BR/E	Escutcheon with Cover	Mortice

Die Cast Brass Furniture

A range of furniture in die cast brass with 5/16" (8mm) spindles, ideally suited to the 3474 & 3476 style of locks. Stamped brass rose is an optional extra. Also available in chrome plated finish. This oval knob with ring turn is ideal for cabin doors.



Brass	Furniture Type	Finish
3477/CP	Oval knob with Ring	Chrome Plate
3477/BR	Oval knob with Ring	Brass

Die Cast Brass Furniture

A range of furniture in die cast brass with 5/16" (8mm) spindles, ideally suited to the 3474 & 3476 style of locks. Stamped brass rose is an optional extra. Also available in chrome plated finish.



Brass	Furniture Type	Sizes	
3478/BR	Oval Knob & Knob	Ring: 1½"	35mm
3485/BR	Lever	Lever: 3"	75mm
3482/BR	Rose	Rose: 1½"	45mm



Turn & Release Toilet Door Furniture

We offer two styles of toilet door furniture to suit our lock 3501. Both cast brass with a polished finish, there is an oval turn with plain rose or a curved turn with raised edge rose. Supplied with a 5mm spindle and external emergency release. Also available chrome plated.

3510



3511



Brass	Chrome	Overall Diameter	Projection
3510/BR	3510/CP	1½" 35mm	1½" 28mm
3511/BR	3511/CP	1½" 35mm	1¼" 30mm



Door, Hatch & Interior Fittings

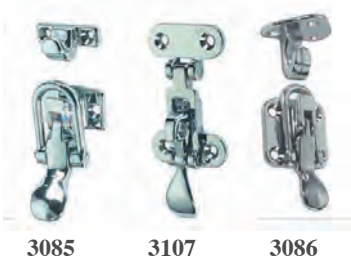

Toggle Fasteners

Die cast in brass in three patterns. Natural finish or chrome plated.

Brass	Chrome	Overall Size	Pattern
3085/BR	3085/CP	2 7/8" x 1 3/8" 72 x 35mm	Vertical to Vertical
3086/BR	3086/CP	3" x 1 1/4" 75 x 32mm	Vertical to Horizontal
3107/BR	3107/CP	4 1/4" x 1 7/8" 110 x 48mm	Vertical to Vertical for Padlock

3085 3107 3086

Anti-Rattle Fastener

The cam mounted arm increases pressure as it moves across the plate, stopping any closure from rattling. Manufactured in brass and available natural or chrome plated.



Brass	Chrome	Arm Plate Dimensions	Striking Plate Length
8155/BR	8155/CP	1" x 1 1/8" 25 x 33mm	3" 75mm

Turn Buttons

Buttons only available in brass, buttons on plates in brass and chrome.



Buttons		Buttons on Plates		
Brass	Length	Brass	Chrome	Diameter
8150/BR/050	2" 50mm	8151/BR/050	8151/CP/050	2" 50mm

Automatic Button

A gravity operated locker catch which simply swings to one side to allow opening. Cast in brass, and complete with screw bush, it is available in polished finish or chrome plated.



Brass	Chrome	Width
8154/BR	8154/CP	1 1/4" 31mm

Double Ball Catch

Chrome Plated brass with Stainless steel balls.



Brass	Length x Width
8483/BR/049	1 15/16" x 3/8" 49 x 10mm

Locker Catch

Spring loaded rocking catch and keeper in die cast brass.



Brass	Plate Length
3091/BR	1 1/4" 32mm

Push Button Catch

Manufactured in brass and available polished or chrome plated. Supplied complete with striking plate. Maximum door thickness 1" (25mm).



Brass	Chrome	Latch Dimensions	Knob Diameter
3092/BR	3092/CP	1 1/2" x 3/4" 38 x 20mm	1 1/16" 30mm

Cupboard Latch

Brass construction. Available in left and right hand. (Right hand illustrated).



Brass	Hand	Size
3114/BR/LH	Left	3 1/4" x 1"
3114/BR/RH	Right	80 x 25mm

Oval Knob & Spindle

Brass knob to suit 3114 latch.



Part No. 3853/BR

Spindle & Rose

Brass operating spindle to suit 3114 latch.



Part No. 3852/BR

Box Key

Brass key to operate 3852 spindle.



Part No. 1612



Swallow Tail Hasp & Staple

Cast brass and polished this fitting was first made by us over 100 years ago.

Length: 8½" 216mm. Width across tail: 4¾" 120mm

Part No. 8951/BR/220

Hasp & Staple

Heavy duty cast brass and polished, these hasps & staples should not be confused with standard pressed or lightweight die castings.



Brass	Length	Width
8955/BR/075	3" 75mm	1" 25mm
8955/BR/094	3¾" 95mm	1⅜" 0mm
8955/BR/112	4½" 114mm	1⅜" 30mm
8955/BR/150	6¼" 158mm	1½" 30mm

Mini Hasp

Brass	Chrome	Length	Width
4107/BR	4107/CP	2⅝" 55mm	2" 50mm



Turn Button Hasps

Brass	Length	Width
8930/BR/075	3" 75mm	1⅜" 30mm
8930/BR/106	4¾" 112mm	1½" 38mm



Hatch & Skylight Fasteners

Part No.	Part No.	Bolt Size	Base Plate
8784/BR	8784/CP	2" x 5/8" 50 x 8	1⅞" x ¾" 47 x 20mm

Fitted with Stainless Springs and Pins - 6g Counter Sunk screws

Holding Down Bolt

Part No.	Bolt Size	Fork Base Plate
8789/BR/075	3" x 3/8" 75 x 10mm	2¼" x ¾" 60 x 19mm
8789/BR/150	6" x 1/16" 150 x 11mm	1¾" x 1¼" 44 x 44mm

Table Screws

Part No	Plate Sizes	Screws
8786/BR	Rectangle 1⅞" x 1⅝" 36 x 25mm	Thumbscrew 3" x 3/8" 75 x 10mm
8787/BR	Round Diameter 2" 50mm	Screw Eye 3" x 3/8" 75 x 10mm
BR/SD238 -POL	3 part set - Oval Handle	2"x 1/2" 50mm x 12mm

Brass Hooks

	Single		Double	Compact
Height	1½" 38mm	2" 50mm	2½" 60mm	Projects ¼" 20mm
Brass	8260/BR/037	8260/BR/050	8262/BR	0691/BR
Chrome	8260/CP/037	8260/CP/050	8262/CP	0691/CP

Folding Coat Hook

Brass	Type	Height O.A.	Projection (in use)	Projection (folded)
8302/BR	3-Arm	3" 75mm	3⅜" 85mm	¾" 19mm
8303/BR	4-Arm	4¾" 122mm	5⅝" 128mm	¾" 19mm



8786

BR/SD238-CP

8787

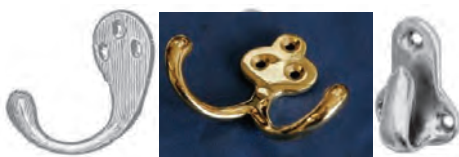



Door, Hatch & Interior Fittings

Flush Rings

These Flush Rings are high quality with a generous recess to allow finger access to the ring.



Rectangular with Catch

Brass	Chrome	Length
8480/BR/057	8480/CP/057	57 x 40mm



Round



Rectangular

Brass	Chrome	Length
8500/BR/037	8500/CP/037	1 ¹ / ₁₆ " x 1 ³ / ₁₆ " 40x30mm
8500/BR/050	8500/CP/050	2" x 1 ¹ / ₂ " 50x38mm
8500/BR/069	8500/CP/069	2 ¹ / ₄ " x 1 ⁷ / ₈ " 70x48mm
8500/BR/075	8500/CP/075	3" x 2 ¹ / ₂ " 75x64mm

Brass	Chrome	Length
8502/BR/050	8502/CP/050	50mm Dia.
8502/BR/062	8502/CP/062	65mm Dia



Heavy Duty Lifting Ring with Catch

Heavy duty brass fitting, which can be operated with two or more fingers from the outside. Also fitted with removable inner handle.

Brass	Chrome	Plate Dimensions
8481/BR	8481/CP	4" x 3 ³ / ₈ " 98 x 80mm



Heavy Duty Lifting Ring without Catch

Flush brass fitting enabling two or more fingers to be used for heavier hatches.

Brass	Chrome	Dimensions
8482/BR	8482/CP	3" x 2" 75 x 55mm



Button Draw Pulls

Polished brass or chrome ideal for small draws.

Brass	Chrome	Dimensions
9119/BR	9119/CP	Dia 32mm x 33mm with M4 Internal Thread



Brass Drop Ring - Forged

A high load fitting with a deep section forged housing and large forged ring for extra strength and ease of use. In polished brass or chrome plated.

Brass	Chrome	Housing Dimensions	Ring Inside Diameter
8525/BR	8525/CP	2 ³ / ₄ " x 1" 70 x 5mm	1" 5mm



9114

Flush Sliding Door Pull

Cast polished brass or chrome plated in two styles. The 9114 can also be used as a drawer pull.



Brass	Chrome	Width	Length
9111/BR/075	9111/CP/075	1 ⁵ / ₈ " 42mm	3" 76mm
9111/BR/100	9111/CP/100	2" 50mm	4" 100mm
9114/BR/075	9114/CP/075	1 ³ / ₄ " 43mm	3" 76mm
9114/BR/100	9114/CP/100	1 ⁷ / ₈ " 48mm	4" 100mm

9111



Flush Drawer Handle

All brass construction with polished finish. Chrome available to order.

Brass	Dimensions	
9113/BR/075	3" x 1 1/8"	75 x 47mm
9113/BR/087	3 1/2" x 2"	89 x 50mm



Drawer Pull

A lightweight drawer pull in pressed brass, polished or chrome plated.

20mm Projection

Drawer Pull

Cast brass drawer pull in polished brass finish or chrome plated.

Brass	Chrome	Dimensions
9112/BR	9112/CP	3 3/4" x 1 1/2" 95 x 8mm



Sash or Door Handles

Cast brass with a polished finish. Can be chrome plated to order.

Brass	Length	Projection
9121/BR/140	5 1/2" 140mm	1 1/8" 29mm



Canted Brass Handle

Cast in brass and then polished. Also available chrome plated.

Brass	Length	Projection
9122/BR	6" 150mm	1 1/8" 35mm
9122/CP		

Barrel Bolts

Solid brass extrusions in straight and cranked patterns, supplied polished or chrome plated.

Straight Pattern



Brass	Chrome	Length	
9011/BR/050	9011/CP/050	2"	50mm
9011/BR/062	9011/CP/062	2 1/2"	64mm
9011/BR/075	9011/CP/075	3"	75mm
9011/BR/100	9011/CP/100	4"	100mm
9011/BR/150	-	6"	150mm

Cranked Pattern



Brass	Chrome	Length	
9012/BR/075	9012/CP/075	3"	75mm
9012/BR/100	9012/CP/100	4"	100mm

Cabin Hooks

Silent pattern in brass or chrome plate finish. Standard pattern also available.

Silent Pattern



Brass	Chrome	Length	
8802/BR/062	8802/CP/062	2 1/2"	62mm
8802/BR/075	8802/CP/075	3"	75mm
8802/BR/100	8802/CP/100	4"	100mm
8802/BR/150	8802/CP/150	6"	150mm
8802/BR/200	8802/CP/200	8"	200mm



Door, Hatch & Interior Fittings

Brass Hinges

British made solid brass hinges available matt, polished or chromed, depending on size and type.

Butt Hinges



Matt	Polished	Chrome	Size	
			Length x Width (open)	
8971/BR/025	8972/BR/025	8971/CP/025	6" x 5/8"	125 x 16mm
8971/BR/037	8972/BR/037	8971/CP/037	6½" x 7/8"	38 x 22mm
8971/BR/044	---	---	---	---
8971/BR/050	8972/BR/050	8971/CP/050	2" x 1"	51 x 29mm
8971/BR/062	8972/BR/062	8971/CP/062	2½" x 1 3/8"	64 x 35mm
8971/BR/075	8972/BR/075	8971/CP/075	3" x 1 5/8"	76 x 41mm
8971/BR/100	---	---	---	---

Brass Lift-Off Hinges

Extruded brass with brass pin. Satin finish. The hand is determined by which half retains the pin.



Left Hand	Right Hand	Size Length x Width (open)
8975/BR/LH/050	8975/BR/RH/050	51 x 29mm
8975/BR/LH/062	8975/BR/RH/062	64 x 35mm
8975/BR/LH/075	8975/BR/RH/075	76 x 41mm

Counter Flap Hinge

Extruded brass with brass pin. Polished finish.



Counter Flap	Size Length x Width (open)
8979/BR/025	25 x 75mm
8979/BR/031	32 x 00mm
8979/BR/037	38 x 15mm

Brass Back Flap

Extruded brass with brass pin. Satin finish.



Brass Back Flap	Size Length x Width (open)
8976/BR/031	32 x 48mm
8976/BR/037	38 x 60mm
8976/BR/050	51 x 76mm
8976/BR/062	64 x 02mm



Table Hinge

NEW

To attach folding extension flaps to a table. Polished finish

Polished	Size
8970/BR/TH/031	1¼" x 1¼" 32 x 32mm
8970/BR/TH/037	1½" x 1 11/16" 38 x 43mm

Fancy Hinge

Pressed brass with brass pin and polished finish.



Brass	Chrome	Size
8977/BR/031	8977/CP/031	1½" x 2 9/16" 38 x 66mm

Ball Finial Hinges

NEW

Polished with pin either fixed (F) or loose (L).



Pol	Pin	Size Length x Width
8970/BR/K/050	F	2" x 1" 51 x 29mm
8970/BR/K/062	F	2½" x 1" 64 x 35mm
8970/BR/K/075	L	3" x 2" 76 x 51mm

Continuous Hinge

Supplied in self colour brass with brass pin. 72" (1829mm) length,



Brass	Width Open	Hole Centres
8978/BR/025	1" 25mm	2" 60mm
8978/BR/032	1¼" 32mm	

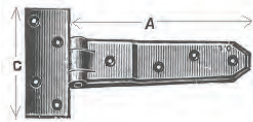

Tee Hinge

Heavy duty cast brass hinges with a polished finish.

Brass	Dimension A		Dimension C		Strap Width	
8875/BR/150	6"	150mm	4"	100mm	1¼"	44mm
8875/BR/200	8"	200mm	5"	125mm	2"	50mm
8875/BR/250	10"	250mm	5½"	140mm	2½"	64mm



Strap Hinge

Heavy duty cast brass strap hinge with a polished finish.

Brass	Length Overall		Width	
8870/BR/200	8"	200mm	1½"	35mm
8870/BR/250	9½"	245mm	1½"	38mm
8870/BR/300	11¼"	298mm	1½"	35mm



Single Tail Hinge

Heavy duty cast brass strap hinge with a polished finish.

Gunmetal	Chrome	Length Overall		Width
8879/GM	8879/CP	6"	150mm	1¼"
				32mm



Skylight Hinge

Cast in gunmetal with a polished finish. Centre section is curved to suit skylight frame.

Gunmetal	Length	Length	Length	Width
8874/GM/320	12½"	3"	4¾"	1¼"
	318mm	75mm	120mm	38mm
8874/GM/430	16¾"	3½"	6½"	1 ¼"
	425mm	90mm	165mm	38mm



Hatch Hinges

Two sizes and patterns of hinges with raised straps to suit hatches. Cast in brass, they are also available chrome plated.

Brass	Strap Length		Base Width		Clearance Under Strap	
0820/BR	5½"	140mm	2⅝"	60mm	1⅜"	35mm
0821/BR	3¾"	95mm	2⅝"	60mm	¼"	7mm



0820/BR

0821/BR

Locker & Strap Hinges

Light duty hinges die cast in brass. Also available in chrome.

Brass	Length		Width	
0833/BR	3⅞"	98mm	1"	25mm
0831/BR	3¾"	95mm	2¼"	57mm
0823/BR	4"	103mm	1¼"	32mm



0833/BR

0831/BR

0823/BR

Separating Hinges

Bronze hinges of high strength that can be separated and reconnected easily by simply pulling a spring loaded pin. Acting as both hinge and catch, they are ideal for hatches, engine covers, lockers etc. Supplied in pairs.

Available in matt finish or chrome.

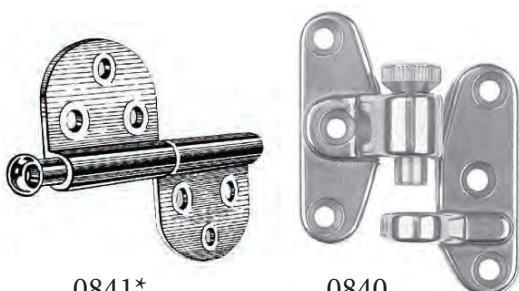

0841*

0840

* Hinges can be joined with a lanyard to aid pin removal

Bronze	Chrome	Width	Length
0840/MB	0840/CP	2" 54mm	2" 54mm
N/A	0841/CP*	60mm	60mm



Door, Hatch & Interior Fittings

Hatch, Skylight & Window Stays

From this group of products it should be possible to select a fitting that will support any kind of opening flap on the boat, be it horizontal, vertical or something in between. All are constructed in brass, with most also available in chrome finish.



8749/BR/178



8749/BR/294



8747/BR



8743/BR



8748/MIN



8748

Brass	Chrome	Length		Approx. Travel	
8749/BR/178	8749/CP/178	7½"	190mm	5½"	140mm
8749/BR/294	8749/CP/294	12"	300mm	9"	230mm
8747/BR/400	-	16"	400mm	14½"	368mm
8747/BR/525	-	21½"	545mm	19"	483mm
8743/BR/250	-	10"	250mm	8"	200mm
8743/BR/350	-	14"	350mm	12"	300mm
8748/BR/MIN	8748/CP/MIN	9¾"	247mm	5¾"	145mm
8748/BR/287	8748/CP/287	11¾"	300mm	8"	200mm
8748/BR/353	8748/CP/353	14½"	368mm	11"	280mm



Self Gripping Door Stop

Cast in brass with a rubber buffer, the hook automatically holds the door in the open position. Available in brass and chrome.

Brass	Chrome	Base Diameter		Projection	
8806/BR/40	8806/CP/40	1⅞"	40mm	1¼"	45mm
8806/BR/50	8806/CP/50	2"	50mm	2⅝"	65mm
Heavy Duty					
8807/BR/58	8807/CP/58	2¼"	58mm	3"	75mm



Spring Door Holder

Spring loaded jaws catch and hold the stem to secure the door in the open position. Available in brass or chrome finish.

Brass	Chrome	Base Size	
3165/BR	3165/CP	2⅞" x ½"	60 x 12mm



Toilet Roll Holder

Traditional style fitting with polished cast gunmetal bracket and wooden roller. It can also be supplied chrome plated.

Gunmetal	Chrome	Overall Width		Overall Height	
8045/GM	8045/CP	6"	150mm	5"	125mm

Door, Hatch & Interior Fittings



Round Hit & Miss - Slide Action

A new style of round vent with slide control

Diameter	Brass	Chrome	SS
4" 100mm	8540/BR/100	8540/CP/100	8540/SS/100
5" 127mm	8540/BR/127	8540/CP/127	8540/SS/127



Round Hit & Miss

Brass	Diameter
8541/BR/100	4" 100mm
8541/BR/150	6" 150mm

Round Grill

Heavy cast brass and polished

Brass	Diameter
8543/BR/159	6¼" 160mm

Round Grill

Cast brass with polished finish

Brass	Diameter
8544/BR	3¼" 82mm



Hit & Miss

Brass	Size
8542/BR/150/075	6" x 3" 150 x 75mm
8542/BR/150/150	6" x 6" 150 x 150mm
8542/BR/225/075	9" x 3" 228 x 75mm
8542/BR/225/150	9" x 6" 228 x 150mm
8542/BR/305/075	12" x 3" 305 x 75mm

Louvre

Brass	Size
8547/BR/150/075	6" x 3" 150 x 75mm
8547/BR/150/150	6" x 6" 150 x 150mm
8547/BR/150/225	6" x 9" 150 x 225mm
8547/BR/225/075	9" x 3" 228 x 75mm
8547/BR/225/150	9" x 6" 228 x 150mm
8547/BR/225/225	9" x 9" 228 x 225mm
8547/BR/305/075	12" x 3" 305 x 75mm
8547/BR/305/150	12" x 6" 305 x 150mm
8547/BR/305/225	12" x 9" 305 x 225mm
8547/BR/305/305	12" x 12" 305 x 305mm



Oblong Slot



Brass	Size
8549/BR/150/075	6" x 3" 150 x 75mm
8549/BR/225/075	9" x 3" 228 x 75mm
8549/BR/225/150	9" x 6" 228 x 150mm

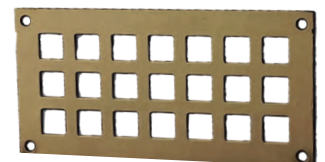

Square Hole

Brass	Size
8548/BR/150/075	6" x 3" 150 x 75mm
8548/BR/225/075	9" x 3" 228 x 75mm
8548/BR/225/150	9" x 6" 228 x 150mm
8548/BR/305/075	12" x 3" 305 x 75mm

Light Duty Twist Vent

Brass with polished finish

Brass	Diameter
8545/BR/130	130mm





Tools

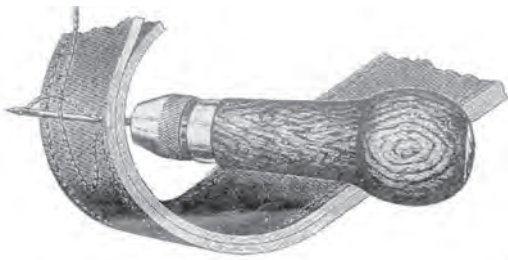

Speedy Stitcher

This very useful tool is basically a hand operated sewing machine, and is suitable for most fabrics and leather. It is supplied with a bobbin of waxed thread, one bent needle and one straight one and full instructions. Sold singularly, they are available in a display box of 6.

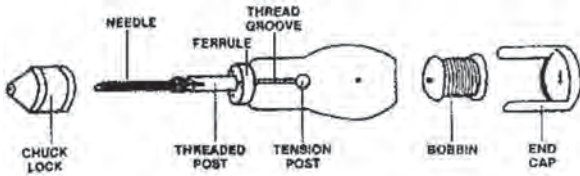

Part No.	Item
1501	Speedy Stitcher complete
1502	Straight Needle
1503	Fine Needle
1504	Curved Needle
1505	Spare Bobbin
1506	Waxed Thread-Heavy
1507	Waxed Thread-Light



1508

Speedy Stitcher Kit

Now available in kit form for convenience and economy. Contains the following items:

- 1 x Sewing awl
- 2 x straight needles
- 2 x curved needles
- 1 x bobbin thread
- 1 x cop of heavy thread 180 yards (164mtrs)

Part No. 1508



1501

Leather Sailmakers Palms

Daveys seaming palms are available in five different qualities. 'lightweight', is an entry level palm with an adjustable buckle. The Seaming Store is a fixed size with ling. The rest of the range are tied back. The 'Roping Palms', with extended thumb guard, come in 'best' and 'store' quality. All palms, except the lightweight version, are lined with hide. Available in left or right hand.

Beeswax

Treating thread with beeswax helps to keep it waterproof and gives it extra strength. Also can be used to waterproof shoes and fabrics.

Sold in 35 gram bars.

Part No. 3056



Left hand	Right hand	Type
3050/00/BU/LH	3050/00/BU/RH	Seaming, lightweight
3050/00/ST/LH	3050/00/ST/RH	Seaming, store quality
3050/00/LH/B	3050/00/RH/B	Seaming, best
3051/00/ST/LH	3051/00/ST/RH	Roping, store quality
3051/00/B/LH	3051/00/B/RH	Roping, best



Lightweight 3050/00/BU30



Roping Store
3051/00/ST



Seaming Best
3050/00/--/B



Roping Best
3051/00/B

Seaming Store 3050/00/ST



Sailmakers Needles-Reduced Edge

Best forged cast steel sailmakers needles, with proven triangular section, that are easy to use and will not damage the cloth. Packed in either 25 of a size or in an assortment of 5 or 20 needles.



Part No.	Size-SWG	Part No.	Size-SWG
3053/00/12	12	3053/00/15	15
3053/00/13	13	3053/00/16	16
3053/00/14	14	3053/00/17	17
3055/00/05	5-assorted needles. 13 to 19		
3055/00/10	10-assorted needles. 14 to 18		
3055/00/20	20-assorted needles 14 to 18, plus 2 sewing needles.		

Rove Punch

An essential tool for neat copper nail & rove work.



Part No.	Max. Nail Gauge
1619/00/030	13
1619/00/035	12
1619/00/045	10
1619/00/055	8
1619/00/	6



Scrapers

A range of strong, general purpose scrapers.

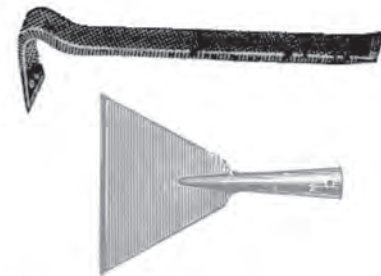

Part No.	Type	Length	Blade Width
1460	Bent	12" 300mm	2 7/8" 70mm
1462	Straight c/w Wooden Handle	Blade - 12" 300mm Handle - 12" 300mm	2 7/8" 70mm
1463	Dry Dock Scraper	9" 230mm	7" 175mm



Chipping Hammer

Chipping hammer, 1lb (500grams) with 12" (300mm) wooden handle. **Part No. 2710**



Caulking Mallet

Made with a hard wood head and Ash shaft. This is the ideal mallet for use with the caulking irons. Head length 240mm - Handle Length 400mm. **Part No. 0946**

Serving Mallet - Hand Forged

Made from Ash and sourced within Europe this is an essential tool for professionally covering standing rigging wires. Designed for seizing and rope parceling. The handle is grooved to work in conjunction with the contoured head.



Head Size (50mm x 140mm)
Length Over All (300mm)
Part No. 0944



Tools

Caulking Irons - Hand Forged

We have a range of carbon steel caulking irons, which are light and comfortable to hold for long periods. A variety of sizes are available to suit the required seam widths.

Part No.	Type	Seam Width	Part No.	Type	Seam Width
1561	Sharp Straight	-	1566	Single Crease	3 - 4mm
1562	Sharp Bent	-	1567	Single Crease	4 - 5mm
1565	Single Crease	2 - 3mm	1568	Single Crease	6 - 7mm



Easy Splice Marlin Spike

This unique splicing tool is stamped from solid brass for strength. It's clever design allows it to be used as marlin spike or a fid.

Part No. 1401/BR - Brass Finish

Part No. 1401/CP - Chrome Plate Finish

Marlin Spikes Standard

Best steel pointed spikes (pencil point end) with black grip and hole.

Part No.	Length		Part No.	Length	
1482/00/150	6"	150mm	1482/00/350	14"	350mm
1482/00/200	8"	200mm	1482/00/400	16"	400mm
1482/00/250	10"	250mm	1482/00/450	18"	450mm
1482/00/300	12"	300mm			



Marlin Spike Hardened

Best steel pointed spikes with black grip and hole.

Part No	Length	
1482/H/150	6"	150mm
1482/H/200	8"	200mm
1482/H/250	10"	250mm
1482/H/300	12"	300mm

These are hardened for professional use



Hardwood Splicing Fid

Made from Ash these are the traditional way to splice rope.

Part No	Length	
0949/OO/200	8"	200mm
0949/OO/250	10"	250mm
0949/OO/300	12"	300mm
0949/OO/400	16"	400mm
0949/OO/500	20"	500mm
0949/OO/600	24"	600mm



Swedish Fids

Stainless steel hollow spike with wooden handle.

2478/SS/170 6¾" (170mm) long.

2478/SS/285 11¼" (285mm) long.



Knives

A range of high quality knives made in the heart of England's steel city of Sheffield.



Green River Knife With 5" (125mm) carbon steel blade, hardwood handle and leather sheath. **Part No. 1500**



3-Piece Yachtsman's Kit
Stainless steel knife, pliers and marlin spike shackle key. Complete with leather sheath. **Part No. 1487**



2-Piece Yachtsman's Kit
Stainless steel knife and marlin spike shackle key. Complete with leather sheath. **Part No. 1487**



Lockspike Captain Knife without Lanyard

A heavy duty, traditionally made, stainless steel pocket knife with a 65mm blade and lockable spike, large capacity shackle key (for pin heads up to 9mm), bottle opener and without lanyard. **Part No. 1488**



Lockspike Bosun Knife

Very practical all stainless steel knife with locking spike, 65mm blade and shackle key slot. Complete with white cotton lanyard. **Part No. 1493**



Lockblade Deckhand Knife

All stainless steel knife, lightweight and compact for ease of carrying and use. Fitted 65mm locking blade and shackle key slot. Complete with white cotton lanyard. **Part No. 1494**



Lockspike Bosuns Mate Knife

All stainless steel knife, lightweight and compact for ease of carrying and use. Fitted 55mm blade & a locking spike. Has a shackle key slot. Complete with white cotton lanyard. **Part No. 1492**



Heavy Duty Riggers Knife

With a thick carbon steel 5½" (140mm) long blade and shaped hardwood handle. **Part No. 1491**



Sailing Safety Knife

All stainless steel knife, lightweight with a hooked end to stop puncture and slipping when cutting. Has a serrated blade. Lightweight plastic handle. No Sheave supplied. **Part No. 1497**



Fastenings

Wood Screws



3470

We stock a wide range of wood screws in silicon bronze to suit the fittings in this catalogue. Supplied in boxes of 100. Other sizes are available to special order.

Wood screws are made to the screw gauge, where the lowest number is the thinnest screw (unlike nails where it is the opposite). The table below gives the approximate metric equivalent size.

Screw Gauge	4	6	8	10	12	14	16	18
mm	2.74	3.45	4.17	4.88	5.59	6.30	7.01	7.72



3472

3472 Raised Counter Sunk Screws

Part No	Size
3472/SB/019/008	3/4" x 8g
3472/SB/025/010	1" x 10g
3472/SB/031/012	1 1/4" x 12g
3472/SB/037/008	1 1/2" x 8g
3472/SB/050/010	2" x 10g

Silicon Bronze

Suitable for all gunmetal fittings, above and below the waterline.

Length	6 Gauge	8 Gauge	10 Gauge	12 Gauge	14 Gauge
3/4" 19mm	3470/SB/019/006	3470/SB/019/008	-	-	
1" 25mm	3470/SB/025/006	3470/SB/025/008	3470/SB/025/010	3470/SB/025/012	
1 1/4" 31mm	3470/SB/031/006	3470/SB/031/008	3470/SB/031/010	3470/SB/031/012	
1 1/2" 37mm	-	3470/SB/037/008	3470/SB/037/010	3470/SB/037/012	
1 3/4" 44mm	-	-	3470/SB/044/010	3470/SB/044/012	
2" 50mm	-	-	3470/SB/050/010	3470/SB/050/012	3470/SB/050/014
2 1/2" 62mm	-	-	3470/SB/062/010	3470/SB/062/012	3470/SB/062/014
3" 75mm	-	-	-	-	3470/SB/075/014

Silicon Bronze Machine Screws

Ideal fastenings for exterior gunmetal fittings. Nuts & washers must be ordered separately. UNC thread.

Length	3/16" 5mm	1/4" 6mm	5/16" 8mm	3/8" 10mm
2" 50mm	3458/SB/050/005	3458/SB/050/006	3458/SB/050/008	
2 1/2" 62mm	3458/SB/062/005	3458/SB/062/006	3458/SB/062/008	3458/SB/062/010
3" 75mm	-	3458/SB/075/006	3458/SB/075/008	3458/SB/075/010
3 1/2" 87mm	-	3458/SB/087/006	-	
4" 100mm	-	3458/SB/100/006	3458/SB/100/008	3458/SB/100/010
6" 150mm	-	-	-	3458/SB/150/010

Silicon Bronze Coach Bolts

Nuts & washers must be ordered separately. UNC thread.

Silicon Bronze Coach Screws



Length	3/8" 10mm	1/2" 12mm	Length	3/8" 10mm	1/2" 12mm
4" 100mm	3452/SB/100/010	3452/SB/100/012	4" 100mm	3456/SB/100/010	3456/SB/100/012
5" 125mm	3452/SB/125/010	3452/SB/125/012	5" 125mm	3456/SB/125/010	3456/SB/125/012
6" 150mm	3452/SB/150/010	3452/SB/150/012	6" 150mm	3456/SB/150/010	3456/SB/150/012
7" 175mm	3452/SB/175/010	3452/SB/175/012	7" 175mm	3456/SB/175/010	3456/SB/175/012
8" 200mm	3452/SB/200/010	3452/SB/200/012	8" 200mm	3456/SB/200/010	3456/SB/200/012
10" 250mm	3452/SB/250/010	3452/SB/250/012	10" 250mm	3456/SB/250/010	3456/SB/250/012

Silicon Bronze Nuts & Washers. UNC thread.



Size	Nuts	Washers
3/16" 5mm	3459/SB/005	3460/SB/005
1/4" 6mm	3459/SB/006	3460/SB/006
5/16" 8mm	3459/SB/008	3460/SB/008
3/8" 10mm	3459/SB/010	3460/SB/010
1/2" 12mm	3459/SB/012	3460/SB/012

Other sizes can be obtained to special order.



Copper Boat Nails & Roves

We have an extensive range of copper nails in both countersunk head and rose head, together with a complementary range of copper roves. All items are packed in boxes of 1 kilo and we show the approximate quantity per box. Other sizes are available to special order, in minimum quantities of 10 kilos.

Copper nails are manufactured to the wire gauge, where the highest number is the thinnest nail. We list below the range of gauges that we supply with the approximate equivalent size in millimetres, which is measured across the flats.

Wire Gauge	mm	Wire Gauge	mm	Wire Gauge	mm
16g	1.65	11g	3.00	7g	4.50
14g	2.00	10g	3.35	6g	5.00
13G	2.36	9g	3.75	4g	6.00
12g	2.65	8g	4.00		

Copper Boat Nails-Countersunk Head

Length	16 Gauge	14 Gauge	13 Gauge	12 Gauge	11 Gauge
$\frac{5}{8}$ " 16mm	5071/CO/016/016	-	-	-	-
Quant.					
$\frac{3}{4}$ " 19mm		5071/CO/019/014	-	-	
Quant.		1390			
1" 25mm		5071/CO/025/014	5071/CO/025/013	5071/CO/025/012	
Quant.		1041	815	603	
$1\frac{1}{4}$ " 32mm	-	5071/CO/031/014	5071/CO/031/013	5071/CO/031/012	
Quant.		833	629	483	
$1\frac{1}{2}$ " 38mm	-	5071/CO/037/014	5071/CO/037/013	5071/CO/037/012	5071/CO/037/011
Quant.		694	524	402	307
$1\frac{3}{4}$ " 44mm	-	-	5071/CO/044/013	5071/CO/044/012	5071/CO/044/011
Quant.			449	345	263
2" 50mm	-	-	-	5071/CO/050/012	5071/CO/050/011
Quant.				301	230
$2\frac{1}{4}$ " 56mm	-	-	-	5071/CO/056/012	5071/CO/056/011
Quant.				267	204
$2\frac{1}{2}$ " 62mm	-	-	-	5071/CO/062/012	5071/CO/062/011
Quant.				241	183
3" 75mm	-	-	-	-	5071/CO/075/011
Quant.					154

	10 Gauge	9 Gauge	8 Gauge	6 Gauge
$1\frac{1}{2}$ " 37mm	5071/CO/037/010	-	-	
Quant.	242			
2" 50mm	5071/CO/050/010	5071/CO/050/009	-	
Quant.	182	151		
$2\frac{1}{4}$ " 56mm		5071/CO/056/009	-	
Quant.		135		
$2\frac{1}{2}$ " 62mm	5071/CO/062/010	5071/CO/062/009	5071/CO/062/008	
Quant.	145	120	101	
3" 75mm	5071/CO/075/010	5071/CO/075/009	5071/CO/075/008	
Quant.	122	101	84	
$3\frac{1}{2}$ " 87mm	5071/CO/087/010		5071/CO/087/008	
Quant.	104		72	
4" 100mm	5071/CO/100/010	-	5071/CO/100/008	5071/CO/100/006
Quant.	91		63	45
5" 125mm	-	-	5071/CO/125/008	5071/CO/125/006
Quant.			51	37
6" 150mm	-	-	-	5071/CO/150/006
Quant.				31





Fastenings

Copper Boat Nails-Rose Head



Length		14 Gauge	13 Gauge	12 Gauge
3/4"	19mm	5075/CO/019/014	-	
	Quant.	1361		
1"	25mm	5075/CO/025/014	-	
	Quant.	1020		
1 1/4"	32mm	-	5075/CO/031/013	5075/CO/031/012
	Quant.	-	616	475
1 1/2"	38mm	-	5075/CO/037/013	5075/CO/037/012
	Quant.	-	513	395
1 3/4"	44mm	-	-	5075/CO/044/012
	Quant.	-	-	338
2"	50mm	-	-	5075/CO/050/012
	Quant.	-	-	295
		11 Gauge	10 Gauge	8 Gauge
2"	50mm	5075/CO/050/011	5075/CO/050/010	5075/CO/050/008
	Quant.	225	176	142
2 1/2"	62mm	-	5075/CO/062/010	5075/CO/062/008
	Quant.	-	142	96
3"	75mm	-	5075/CO/075/010	5075/CO/075/008
	Quant.	-	120	82
3 1/2"	87mm	-	-	5075/CO/087/008
	Quant.	-	-	70
4"	100mm	-	-	5075/CO/100/008
	Quant.	-	-	61

Copper Roves

Supplied in boxes of 1/2 kilo with approximate quantity per 1/2 kilo shown.

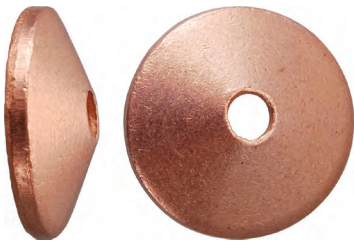

Part No.	Rove Diameter	Nail Gauge	Quant. per 1/2 kilo
5072/CO/008⁵	1/16" 8mm	14g	1150
5072/CO/010³	1/8" 10mm	13g	700
5072/CO/011⁷	1/16" 11mm	12g	470
5072/CO/012¹	1/2" 12mm	10g & 11g	340
5072/CO/014⁹	1/16" 14mm	9g	250
5072/CO/016⁵	1/8" 16mm	7g & 8g	190
5072/CO/019³	1/4" 19mm	6g	130

Brass Wing Nuts

Manufactured in the UK can be made in any thread subject to volumes.



Part No	Width - Thread
3461/SB/06	30mm - 1/4"
3461/SB/08	38mm - 5/16"
3461/SB/10	45mm - 3/8"
3461/SB/11	51mm - 7/16"
3461/SB/12	59mm - 1/2"

Marine Grade Studding

This is held on 3' lengths or 1m lengths depending on supplier.



Part No	Brass - Thread
5085/SS/08	M8
5085/SS/10	M10
5085/SS/12	M12
5085/BR/W1-2	1/2"
5085/BR/W5-8	5/8"
5085/BR/W3-4	3/4"
5085/BR/M5	M5

Galvanised Rosehead Boat Nails



	Length		Gauge		Approx. Quantity	
					Per Kg	Per Box
5061/GA/050	2"	50mm	3/16"	5mm	112	2800
5061/GA/065	2 1/2"	65mm	3/16"	5mm	98	2450
5061/GA/075	3"	75mm	1/4"	6mm	48	1200
5061/GA/090	3 1/2"	90mm	1/4"	6mm	38	950
5061/GA/100	4"	100mm	1/4"	6mm	34	850
5061/GA/115	4 1/2"	115mm	5/16"	8mm	20	500
5061/GA/125	5"	125mm	5/16"	8mm	18	450
5061/GA/150	6"	150mm	3/8"	10mm	10	250
5061/GA/175	7"	175mm	3/8"	10mm	9	225
5061/GA/200	8"	200mm	3/8"	10mm	6	150



Jeffery's No.2 Black Marine Glue

This traditional product, now owned by Davey & Company, has been the premier choice for traditional deck seaming around the world for decades.

Still produced in England from the original formula, it is as reliable today as throughout the last century. It will adhere tenaciously to the seam for many years, remaining flexible in low temperatures and withstanding softening at high temperatures.

To apply, once carefully heated to a working temperature of around 370 degrees F (190 degrees C) it can be poured onto the prepared seams. Two applications are needed to ensure that all steam and air are released. Average usage 1kg to 10 metre run.

Part No. 5025/00/0125 12.5 kg (27½lbs)

Part No. 5025/00/025 25.0 kg (55 lbs)



Oakum

Best navy oakum steeped in Stockholm Tar. Generally used for caulking below the waterline, due to its high durability.

Part No. 1569/00/04 4 kg coil

Part No. 1569/00/12 12 kg box



Caulking Cotton

Soft, top quality caulking cotton made up of 8 strands totalling an uncompressed diameter of approximately 5/16" (8mm). Supplied in balls of ½ kilo.

Part No. 1570

Red Lead Powder

A bright orange powder with strong preservative properties. When mixed with linseed-oil putty it makes 'red lead putty' for use as stopping in seams below the waterline on wooden craft.

An appropriate ratio of 16 parts putty to 1 part red lead powder is about the right proportions, with linseed oil added to modify the mixture to the required consistency.

Part No. 5049/00/001 1 kg. tub

Part No. 5049/00/025 25 kg. bag



Gripfast Nails

Made from Silicon bronze and with ribbed/ringed shanks these nails give excellent grip in to the timber. Other sizes are available. Sold per KG

Part No	Size	Part No	Size
5074/SB/012/016	1/2" x 16g	5074//SB/037/012	1 1/2" x 12g
5074/SB/019/012	3/4" x 12g	5074/SB/044/008	1 3/4" x 8g
5074/SB/019/014	3/4" x 14g	5074/SB/050/012	2" x 12g
5074/SB/025/014	1" x 14g	5074/SB/056/010	2 1/4" x 10g



Boat Care



Daveyshine

A high performance metal cleaner and polish ideally suited to bronze, brass, copper, stainless steel, aluminium, chrome and other marine metals. Its smooth paste formula is easy to apply accurately and when removed leaves a shiny surface and protective film, which delays re-tarnishing. Even heavily tarnished fittings can be restored. The handy 170 gram tub is long lasting as Daveyshine is used sparingly and the wide tub opening allows every last gram to be used.

Key Features:

- Cleans and polishes in one product
- Leaves protective coating
- Non-toxic, non-abrasive, non-inflammatory
- No harsh acids, caustics or abrasives
- Low allergic risk
- Non spill formula & tub
- Also excellent for restoring fibreglass, plexi-glass, eisenglass and lexan.

Part No. 5010/00/170

Lanoguard

Lanoguard is an all-purpose anti-corrosive, lubricant and water proofing agent that delivers superb results in a wide variety of applications. It can be used on metals, leather, plastics and other materials such as fibreglass.

Its principal ingredient is lanolin (wool grease), a natural oil that has been used throughout the centuries for the protection of weapons, leather and marine equipment. The combination of natural lanolin and today's technology makes Lanoguard's uses almost limitless.

Key Features:

- Tenacious lubricant
- Rust inhibitor/anti-seize
- Long lasting protector
- Non conductive
- Outstanding waterproofing
- Safe for leather, vinyl and rubber
- Environmentally friendly
- Non toxic and non carcinogenic Part

Part No. 5057/OO/050

500ml Liquid Spray Refill

Part No. 5057/OO/200

2 Litre Liquid Spray Refill

Part No. 5057/OO/500

5 Litre Liquid Spray Refill

Part No. 5056/SPRAY/500

500ml Spray Head for bottle

Part No. 5056/SPRAY/UNI

Universal Professional Spray head (Cut to length)



2 Lt with Uni Sprayer



500ml with 500 Sprayer



Boat Care Starter Kit



Boat Trailer Kit

The Lanoguard Boat Care Starter Kit comprises Marine Spray 500ml together with Marine Grease 250ml and a trigger sprayer
Part No. 5055/OO/STR

The Lanoguard Boat Trailer Kit comprises the Marine Spray 2L together with the Marine Grease 600ml and spray-kit
Part No. 5055/OO/KIT



Lanoguard Grease

Ideal for all marine applications including stern glands, linkages, sea cocks etc.
Part No. 5055/OO/060 600ml Grease

Stockholm Tar

A strongly preservative thick liquid used to preserve natural cordage and timber. Traditionally used to coat servings on rigging and is the substance added to oakum to stop it rotting. Worth having for the wonderful smell alone.

Part No. 2809/00/01 1 kg tub

Part No. 2809/00/02 2.5 kg tub

Part No. 2809/00/05 5 kg tub



Index



A			
Allthread Bar	78	Clew fittings	32
Anchors & Accessories	27	Coach bolts & Coach Screws	76
Anti rattle fasteners	64	Coaming leads	18
Art deco lights	51	Coat hooks	65
Ash blocks	35-38	Continuous Hinge	68
		Convex Brass	20
B		Copper nails & roves	77 - 78
Back stay levers	31	Cowl ventilators	10
Bar cleats	13	Custom Work	5
Barrel bolts	67		
Barton Marine	46-47	D	
Beeswax	72	Daveyshine	80
Belaying pins	33	Deck filling plates	11
Berth lights	49-54	Deck Glands	54
Binnacle rings	21	Deck hatch - bronze	11
Black marine glue	79	Deck head lights	50-51
Blocks	35 to 47	Deck plates - threaded	22
Boarding ladder fittings	30	Deck Prisms	8 & 9
Boat badge	29	Deck screws	11
Boat nails - copper	77 & 78	Door & drawer pulls	65-67
Boat nails - galvanised	78	Door catches	62-64 & 70
Boathooks & staves	30	Door furniture	62-63
Bollards	14 & 15	Door holders	70
Boom crutch sockets	25	Door locks	62
Boom end fittings	32	Down lighters	53
Bow eye	20-22	Drain plugs	11
Bow Rollers	26-27	Draw Bolts	67
Bowsprit plates	32	Draw Pulls	66-67
Bronze blocks	37-39	Drip cup	7
Bronze shackles	33	Drop rings	66
Bronze stanchions	29		
Bronze stars	25	E	
Bulkhead Fairleads	17	Easy Splice marlin spike	74
Bulkhead Lights	52	Engine control levers & Panels	20
		Eye bolts	20 - 22
C			
Cabin hooks	67	F	
Cabin Lights	49-55	Fairleads	16 to 19
Cam cleats	44	Faucets	49
Captive rowlock	27-28	Fender eye plates	19-20
Caulking irons	74	Fids	74
Caulking cotton	79	Fiddle Rails Brass	47
Caulking Mallets	73	Flag clips	61
Chain pipes	27	Flag staff sockets	25
Chain plates	32	Flue pipe & fittings	48
Cleats	12 & 15	Flush rings	66
		Foot Blocks Brass	39
		Fuel tank vents & Fillers	11
		Furling gear	31



Index

G		L	
Gaff span shackles	33	Lacing hooks & eyes & Bridges	.19-20
Galileiglass	60	Ladder fittings	30
Galley pumps	49	Lanoguard	80
Galvanised nails	78	LED's	60
Gimbal lamps	54-55	Lead Lines	61
Glands	54	Lewmar	40-41
Glazed ventilator	10	Lifebuoy Holder	47
Globe lamp	46	Lifting Cleat	14
Glue	79	Lifting rings	66
Goosenecks	31	Lighting	49-60
'Grabit' boathook	30	Locks	62-65
Grills	71	Louvre vents	71
Gripfast Nails	79		
Guarded light	49-52		
H		M	
Half band & spikes	31	Machine screws	76
Handrail stanchions	29	Mains voltage lights	53
Handles	66-67	Magnesium eye bolts	21
Hasp & staples	65	Mallets	73
Hatch bronze	11	Marlin spikes	74
Hatch fasteners	65	Mast bands	32
Hatch Slides	34	Mast lights	53 & 55
Hatch stays	70	Metal cleaner/polish	80
Highfield levers	31	Mortice locks	62
Hinges	68 & 69	Mushroom ventilators	10
Hit & miss vents	71		
Holding down bolts	65	N	
Hooks	36 & 65	Nails	77-79
Horns	61	Name Plates	11
Hot Pot stove	48	Navigation lamps	54, 56-59
HYE Blocks	42 - 45	Needles	73
I		Night vision lights	51
Inclinators	47	Nuts	76-78
Inglefield clips	61		
Ignition Barrels and Panels	20	O	
Interior lights	49-55	Oakum	79
J		Oar clamp	26
Jack Staff	47	Oarlocks	27-28
Jamming Cleats	12 & 44	Oil lamps	54-55
Jeffery's glue	79	Outboard Bracket	47
'Jelly mould' lights	51		
K		P	
Keel band - brass	20	Pad eyes	20
Knives	75	Palms	72
		Parrel beads	32
		Pelican hook	33
		Portlights	8-9
		Portlight Seals	7

Index



Prisms - deck	8 & 9	Spinnaker pole fittings	34
Pulley blocks	35 to 47	Spare Glasses	59
Pumps	49	Splicing Fids	74
		Spreader Lights	55
R		Stainless steel blocks	45
Rail hinge	30	Stanchion eyebolt	21
Red lead powder	79	Stanchions & bases	29
Reefing claw	32	Stand-up kits	36 & 44
Retractable Hook	20	Stars	25
Riggers knife	75	Stemhead fittings	26 - 27
Rigging Screws	39	Stemhead rollers	26 -27
Rim locks	63	Step light	49
Ring bolts	21 & 22	Stockholm tar	80
Rings	7	Storm glass	61
Roller Fairleads	16	Studding	78
Roof lights	51	Switch Panels	20- 59
Roves	78		
Rove Punches	73	T	
Rowlocks & sockets	27-28	Table screws	65
Rubbing band - brass	20	Tackle hooks	36
Rudder gear	23-24	Tallow	60
		Teak blocks	38
S		Tiller fittings	23
Sail track & slides	34	Toggle fasteners	64
Sailmakers palms	72	Toilet roll holder	70
Scrapers	73	Track & Fittings	34
Screw eyes	22	Tufnol cleats	13
Screws	76	Tufnol type blocks	42 to 45
Seals For Portlights	7	Turnbuckles	39
Search Lights	55	Turn Buttons	64
Seat Bases	47		
Separating Hinges	69	V	
Serving Mallets	73	Ventilators	10 & 71
Shackle plates	21		
Shackles	33	W	
Sheaves	36 & 44	Webbing Retainers/Bridges	20
Sheet Cleats	13	Weatherproof lights	52
Sheet Blocks	39	Wicks	59
Sheet leads	18	Winches and Windlass's	40-41
Shell vents	10	Windscreen fittings	6
Shroud plates	32	Wire rope blocks	44 & 45
Silent Cabin Hooks	67	Wing Nuts	78
Skylight lifts	70	Wood screws	76
Sliding gooseneck	31	Wooden block	35 to 38 & 46 to 47
Slip bolts	67	Wooden cleats	13
Snap shackles	33	Wykeham Martin furling gear	31
Snatch Blocks	39		
Solid fuel stove	48	Y	
Sounding leads	61	Yachtsmans kit	62
Speedy stitcher	72		



Trophies Made to Order
Ask the Sales Team
info@davey.co.uk



DAVEY & CO
LONDON LIMITED • Est. 1885



Woodlands Business Park
Tenpenny Hill, Thorrington,
Colchester, Essex, CO7 8JD

T: +44(0)1206-500945 F: +44(0)1206-500949

e: info@davey.co.uk www.davey.co.uk

**Distributors to the Trade for
Traditional Yacht and Ships Fittings**